



COMMERCIAL REFRIGERATION EUROPE SOLSTICE® L40X (R-455A) IMPLEMENTATION GUIDELINES

**EN 378 COMPLIANT & SUSTAINABLE SYSTEM ARCHITECTURES
WITH A2L REFRIGERANTS.**

Honeywell

TABLE OF CONTENTS (1/2)

Introduction, Purpose of this Deck & Target Audience

Solstice® Solutions for New Refrigeration Systems

System Design with A2L Refrigerants: The EN Standard 378

Typical System Architectures for Commercial Refrigeration & A2L Charge Size Calculation

- Outdoor condensing units connected to display cabinets
- Outdoor condensing units connected to display cabinets / Piping runs through back area
- Outdoor condensing units connected to cold/freezer room
- Indoor condensing units connected to cold/freezer room
- Centralized direct expansion system with machinery room
- Centralized cascade system with machinery room
- Centralized cascade system with machinery room / A2L refrigerant in direct expansion
- Waterloop system with outdoor dry cooler
- Stand-alone (plug-in) system

TABLE OF CONTENTS (2/2)

Additional Considerations for Risk Assessment and Mitigation

- Machinery Room for A2L Refrigerants
- Electrical Supply
- PED Considerations when using A2L Refrigerants

References

Appendixes

- Appendix A: EN 378 vs. IEC and EN 60335-2-89
- Appendix B: Risk Assessment Checklists
- Appendix C: Requirements for Alternative Provisions

INTRODUCTION



A2L Refrigerants: Ensuring Compliance, Safety and Energy Efficiency

- The 2015 F-gas regulation is driving industry to use lower GWP refrigerants in many applications. The EU regulation e.g. introduces a ban on new equipment using refrigerants with a GWP of >2500 since 1st January 2020, and with a GWP>150 on 1st January 2022. The regulation also introduces a phase-down, related to GWP and measured in CO₂ equivalents, which will drive industry to use lower GWP options. As a result, a new family of refrigerants, both pure fluids and blends, has been developed – these are Hydro-Fluoro-Olefins (HFO). A feature of several of these products is that they exhibit lower flammability (sometimes referred to as “mildly flammable”). To recognize this, and their difference from higher flammability refrigerants such as hydrocarbons, a new A2L classification has been introduced by ASHRAE based on the international standard ISO 817. (*Source FETA*)

- In the classification of refrigerants from the ISO 817 standard, the letter indicates the level of toxicity:
 - A = refrigerants with lower toxicity
 - B = refrigerants with higher toxicity

whereas the number indicates the level of flammability:

- 1 = non-flammable
- 2L = lower flammability (‘mildly flammable’)
- 2 = flammable
- 3 = higher flammability

(*Source EPEE*)

	Safety Group / Classification	
	Lower Toxicity	Higher Toxicity
Higher Flammability	A3	B3
Flammable	A2	B2
Lower Flammability	A2L*	B2L*
No Flame Propagation	A1	B1

*A2L and B2L are lower-flammability refrigerants with a maximum burning velocity of ≤ 3.9 in/s (10cm/s)

- **For commercial refrigeration operators and contractors, A2L refrigerants give the highest flexibility in system design, and open the door to system architectures which ensure long-term regulatory and environmental compliance, safety and the highest energy efficiency standards at the lowest Total Cost of Ownership over the life cycle of the installation.**

PURPOSE OF THIS DECK & TARGET AUDIENCE



Help You Define Refrigeration System Design for A2L

- We show you what aspects need to be considered and defined in order to maximize the use of the possibilities of A2L refrigerants and at the same time ensuring compliance with the EN 378 standard.
- The flammability of the A2L refrigerants requires charge limitations based on the **occupancy of the rooms**, the **location of the refrigeration system components** and the **safety characteristics of the refrigerant**.
- Charge size is restricted so that, in the event of a leak, the concentration of A2L refrigerant in air is not dangerous. When calculating the maximum charge size, all rooms through which refrigerant pipe work passes must be considered, not just the rooms where the evaporators and condensing unit/pack are.

Support You with Risk Assessment

- We show you what aspects need to be considered in order to minimize the overall risk, thus making the risk assessment and mitigation easier and less costly.

Target Audience

- Operators of commercial refrigeration systems
- Refrigeration contractors
- Refrigeration system engineers and designers.

SOLSTICE® SOLUTIONS FOR NEW SYSTEMS



Applications / Systems	Low-Temp and Med-Temp	Med-Temp
<ul style="list-style-type: none"> Centralized Systems Condensing Units 	Solstice L40X (R-455A)* <u>A1:</u> Solstice N40 (R-448A)**	Solstice L40X (R-455A)* / Solstice yf (R-1234yf)* / Solstice ze (R-1234ze)* <u>A1:</u> Solstice N15 (R-515B)** / Solstice N13 (R-450A)** / Solstice 513A (R-513A)**
<ul style="list-style-type: none"> Self-Contained Systems (hermetically-sealed) 	Solstice L40X (R-455A)	Solstice L40X (R-455A) / Solstice yf (R-1234yf)
<ul style="list-style-type: none"> Cascade Systems Chillers Flooded Systems 		Solstice ze (R-1234ze)* / Solstice zd (R-1233zd) <u>A1:</u> Solstice N15 (R-515B)**

* Depending on charge size restrictions

** GWP>150 not permitted from 2022 for new multipack systems (commercial use) with a capacity ≥ 40kW (no restriction on retrofit)

Relevant EU F-Gas Regulation Provisions & Implications

- 2020: No GWP ≥ 2500 for**
 - Refrigerators and freezers [...] for commercial use (hermetically sealed systems)
 - Stationary refrigeration equipment, except if intended for application designed to cool products to temperatures below -50°C
- 2022: No GWP ≥ 150 for**
 - Refrigerators and freezers [...] for commercial use (hermetically sealed systems)
 - Multipack centralized refrigeration systems for commercial use with a capacity ≥ 40kW, except in the primary refrigerant circuit of cascade systems where F-gases with a GWP < 1500 may be used.
- No ban on use of virgin refrigerants with GWP < 2500 for service and maintenance.**

SOLSTICE® A2L REFRIGERANT FEATURES



	Solstice L40X (R-455A)	Solstice ze (R-1234ze)	Solstice yf (R-1234yf)
GWP	148*	<1** (not considered a Greenhouse Gas, similar to e.g. R-744 or R-290)	<1** (not considered a Greenhouse Gas, similar to e.g. R-744 or R-290)
ASHRAE Classification	A2L	A2L	A2L
PED	Group 1	Group 2	Group 1
Capacity	Similar to R-404A	ca. 20-25% lower vs. R-134a	Similar to R-134a
Efficiency / COP	ca. 10% higher vs. R-404A	Similar or higher vs. R-134a	Similar to R-134a
Comments		Higher T_{cond} achievable: Heating market (up to 100°C possible in cascade)	

* IPCC AR4

** IPCC AR5

SYSTEM DESIGN WITH A2L REFRIGERANTS



Why EN 378 is the Right Standard to Follow in Commercial Refrigeration

- Even if so-called product standards like EN 60335-2-89 have the priority over so-called horizontal standards like EN 378, this applies only for equipment and systems which specifically fall under the scope of the product standard.
- The EN 60335-2-89, in its current version, does not cover equipment or systems containing a charge >150 gr. of flammable refrigerant (whatever the flammability class). We expect that it will take at least 2 years until the EN 60335-2-89 be updated, and the content of the update remains unknown at this stage. If based on the newest changes to the international standard IEC 60335-2-89, split systems with >150 gr. of flammable refrigerant remain uncovered by this standard (click [here](#) if you want to know more about the IEC 60335-2-89 and its relevance for A2L refrigeration systems). As a conclusion, the standard EN 60335-2-89, even assuming some future changes based on the new version of the IEC 60335-2-89, does not cover most of A2L systems, so we need to apply another standard.
- For commercial refrigeration systems which are set-up out of several pieces of equipment and components (which might by the way fall individually under the scope of a product standard like EN 60335-2-89), the EN 378 is the primary standard that designers and installers can use when considering the safety and design limitations of a system.
- The European standard EN 378 relates to safety and environmental requirements in the design, manufacture, construction, installation, operation, maintenance, repair and recovery of refrigerating systems and heat pumps. Following this standard will assist contractors to design, manufacture, install, commission and maintain refrigeration systems to ensure best practice.

EN STANDARD 378



- EN 378 consists of 4 parts. It covers most types and sizes of refrigerating systems. Different parts of the standard are intended for different roles.

	Part 1	Part 2	Part 3	Part 4
Designer				
Manufacturer				
Installer				
Maintenance				
Operator				

- The EN 378 is harmonised with the European *Pressure Equipment Directive* 2014/68/EU and the European *Machinery Directive* 98/37/EC with respect to their design, construction, testing, marking and documentation requirements (Part 2).
- There may be additional EU directives, national regulations or local legal requirements (e.g. in relation to ATEX, fire safety and building codes, safety of pressure systems) and it is the common responsibility of the contractor and operator to understand and comply with such requirements.

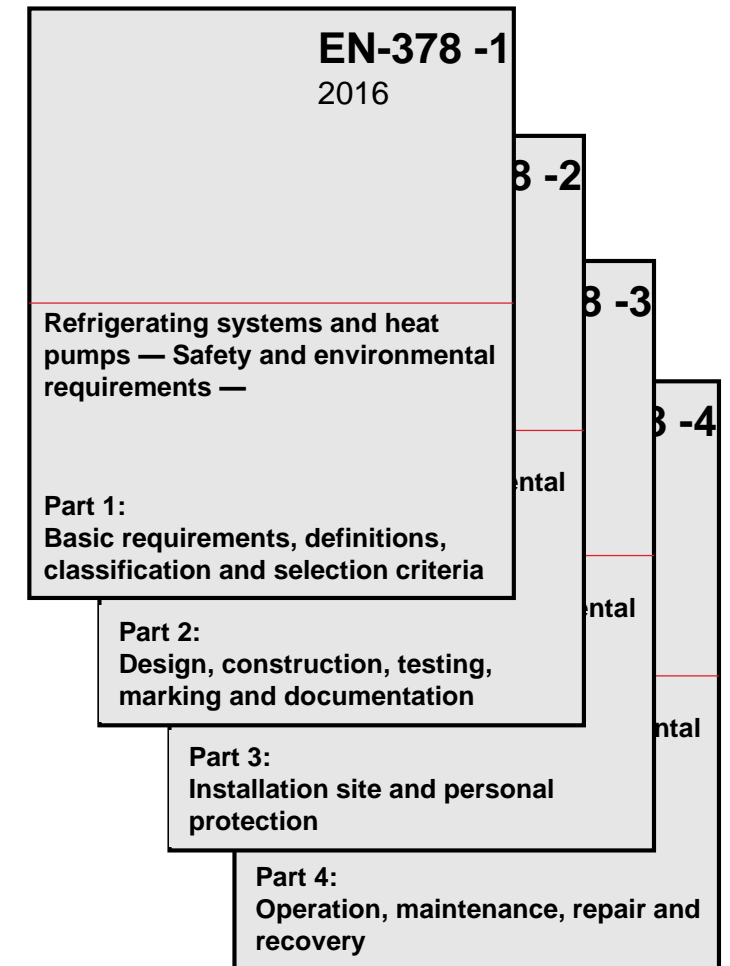

RISK ASSESSMENT



- For a new or refurbished installation, there needs to be a risk assessment carried out which reviews the **application**, the required **refrigerant charge**, the **location of system components**, and the **occupancy of any room containing refrigerant holding components**. This is valid **no matter which refrigerant you use, flammable or non-flammable**.
- The EN 378 standard contains design information crucial to this risk assessment and management process and should always be referred to in the planning stage of an A2L installation. **By choosing the right refrigerant, equipment and location as dictated by EN 378, the probability of forming a flammable atmosphere can be eliminated, making this assessment potentially very straightforward** as many equipment manufacturers are including data to carry out risk assessments within their technical documentation and installation guidelines. (*Source FETA*).
- As a basic guiding principle, refrigerating systems using lower flammability refrigerants (A2L) shall be constructed so that any leaked refrigerant will not flow nor stagnate so as to cause a fire or explosion hazard in areas within the equipment where components which could be a source of ignition are fitted (see EN 378, Part 2, Annex K for a list of relevant ignition sources)
- **Standards offering guidance for risk assessment:**
 - EN 378 Annex G Part 1
 - EN 378 Annex D Part 2
 - EN 378 Annex K Part 1
 - ISO 12100
- **As a non-binding guidance, we have set-up template checklists for conducting risk assessment of refrigerating systems. You can find these risk assessment checklists under the following [link](#).** Honeywell's interactive checklist will also show you that using A2L refrigerants does not require significant additional effort when compared to the use of R-744 or other A1 refrigerants. We also refer to national and regional trade associations, who have published such guidance and template checklists for risk assessment of systems.

DEFINITION OF OCCUPANCY



Occupancy Category Definitions

Occupancy is categorized in 3 different categories: (a) General, (b) Supervised and (c) Authorized



DEFINITION OF SYSTEM LOCATION



Location of the Refrigeration System Components

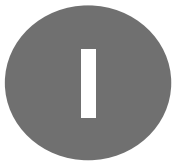

All refrigerant containing parts in occupied space



Compressors and pressure vessels in machinery room or open air



All refrigerant containing parts in machinery room or open air

REFRIGERANT CHARACTERISTICS



Refrigerant Characteristics Needed for Charge Determination

- Annex E of EN 378-1 provides information about the chemical name, chemical formula, safety class, PED fluid group, practical limit, acute toxicity exposure limit (ATEL), oxygen deprivation limit (ODL) or lower flammability limit (LFL) of refrigerants, and other information necessary to calculate the maximum recommended charge of the respective refrigerant. For refrigerants like R-455A which are not yet listed in the latest available version of the EN 378, please refer to EN 378-1 2016 prA1 2019 (updated draft) or use the data in the table below.

Refrigerant	Practical Limit (kg/m ³)	ATEL / ODL * (kg/m ³)	LFL (kg/m ³)	RCL (kg/m ³)	Molecular Mass	QLMV (kg/m ³)	QLAV (kg/m ³)
R-1234yf	0.058	0.47	0.289	0.058	114	0.060	0.145
R-1234ze	0.061	0.28	0.303	0.061	114	0.063	0.152
R-455A	0.086	0.393	0.431	0.086	87.5	0.092	0.216

* Acute-Toxicity Exposure Limit (ATEL) or Oxygen Deprivation Limit (ODL), whichever is lower values taken from ISO 817.

Requirements for Alternative Provisions

- For A1 and A2L refrigerants only, the EN 378 gives the possibility to increase further the maximum refrigerant charge vs. the basic charge calculation if additional safety measures are implemented (e.g. natural or mechanical ventilation, safety shut-off valves and safety alarm in conjunction with a gas detection device, etc.). For more details on the possibilities opened by these alternative provisions and the details of the conditions where these can be implemented, please click [here](#) or see EN 378, Part 1, Clause C.3.

REFRIGERANT CHARACTERISTICS



Definitions

- **Lower Flammability Limit – LFL**

Minimum concentration of refrigerant (kg/m^3) capable of propagating a flame within a homogeneous mixture of refrigerant and air.

- **Refrigerant Concentration Limit – RCL**

Maximum concentration of refrigerant in air (kg/m^3) defined to reduce the risks of acute toxicity, asphyxiation, and flammability hazards.

- **Quantity Limit with Minimum Ventilation – QLMV**

Charge density of refrigerant (kg/m^3) that would result in a concentration equal to the RCL in a room of non-airtight construction with a moderately severe refrigerant leak. QLMV is usually calculated based on the RCL and the molecular mass of the respective refrigerant.

- **Quantity Limit with Additional Ventilation – QLAV**

Charge density of refrigerant (kg/m^3) that, when exceeded, creates an instantaneous dangerous situation, if the total charge would leak within the occupied space. For 2L refrigerants, QLAV is calculated as 50% of the respective LFL.

Working with QLMV/QLAV ensures that the refrigerant concentration due to leaks does not create any risk of flame, of toxic or suffocating atmosphere, provided that some air exchange between the room and outdoors (or the associated rooms) is ensured, that the system itself fulfills the criteria from the EN 378 standard, and that – for QLAV – the appropriate additional safety measures are incorporated.

TYPICAL SYSTEM ARCHITECTURES FOR COMMERCIAL REFRIGERATION | A2L REFRIGERANT CHARGE SIZE CALCULATION



How to Use This Guide

Identify the system architecture of interest



Read the yellow recommendation if available



Go to the appropriate chart for refrigerant charge calculation



Refer to design requirements

DISTRIBUTED SYSTEM TYPE „A“

OUTDOOR CONDENSING UNITS CONNECTED TO DISPLAY CABINETS

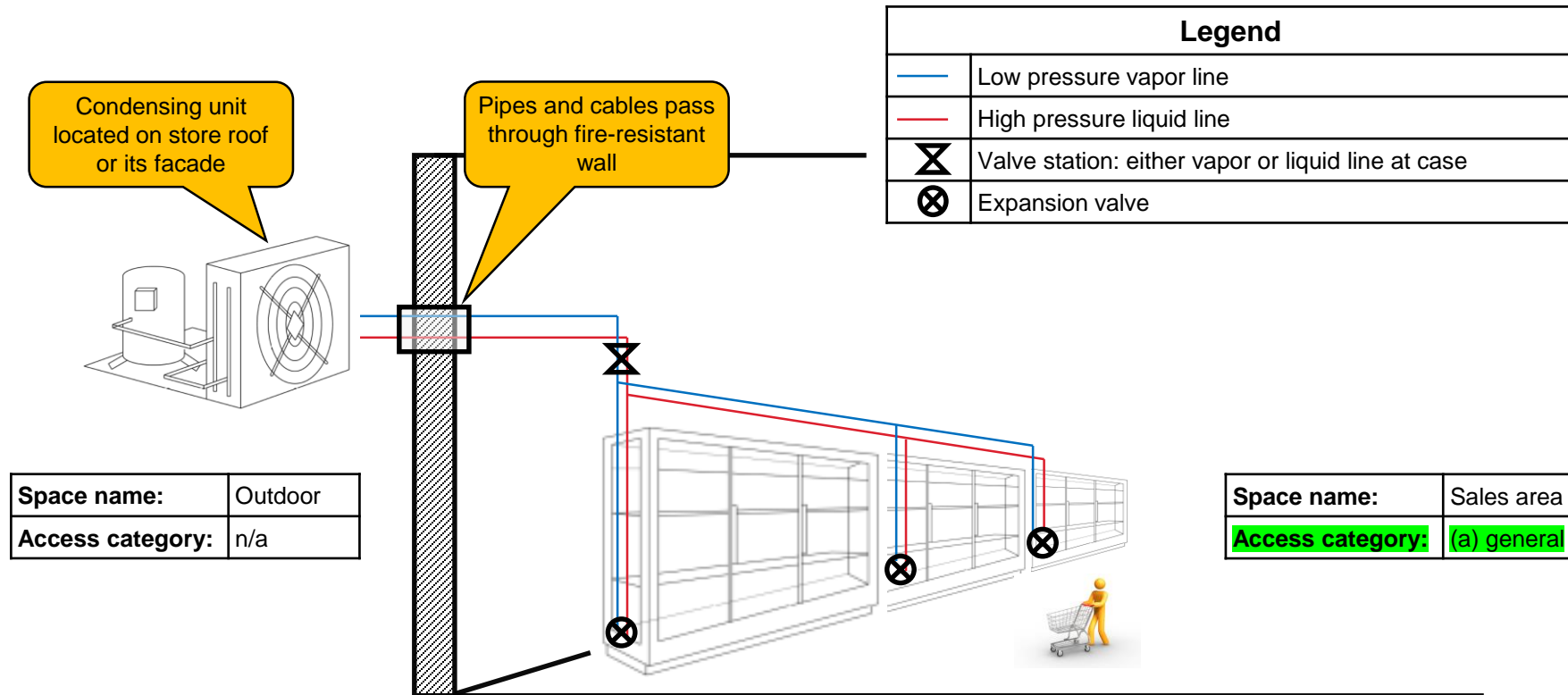

Criteria valid for charge size calculation

- Access category: (a) general
- System location: II

For refrigerant charge calculation, go to Chart 1 for R-455A / R-1234ze / R-1234yf

DISTRIBUTED SYSTEM TYPE „B“



OUTDOOR CONDENSING UNITS CONNECTED TO DISPLAY CABINETS | PIPING RUNS THROUGH BACK ROOM

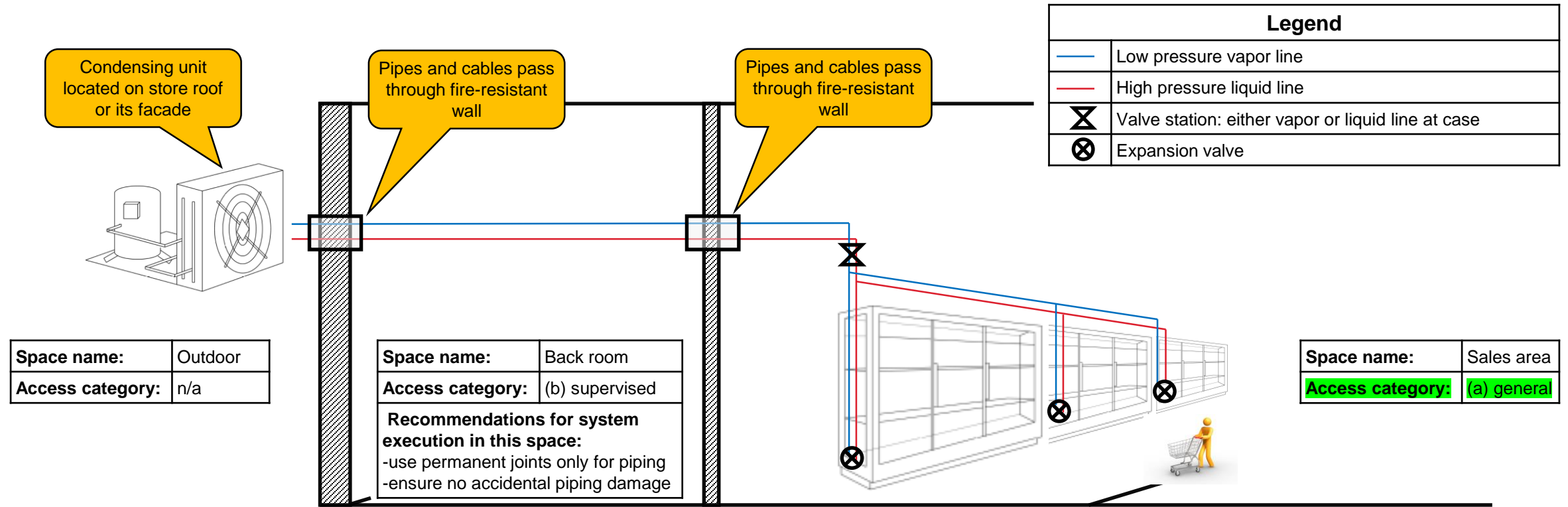

Criteria valid for charge size calculation

- Access category: (a) general
- System location: II

For refrigerant charge calculation, go to Chart 1 for R-455A / R-1234ze / R-1234yf

DISTRIBUTED SYSTEM TYPE „C“

OUTDOOR CONDENSING UNITS CONNECTED TO COLD/FREEZER ROOM

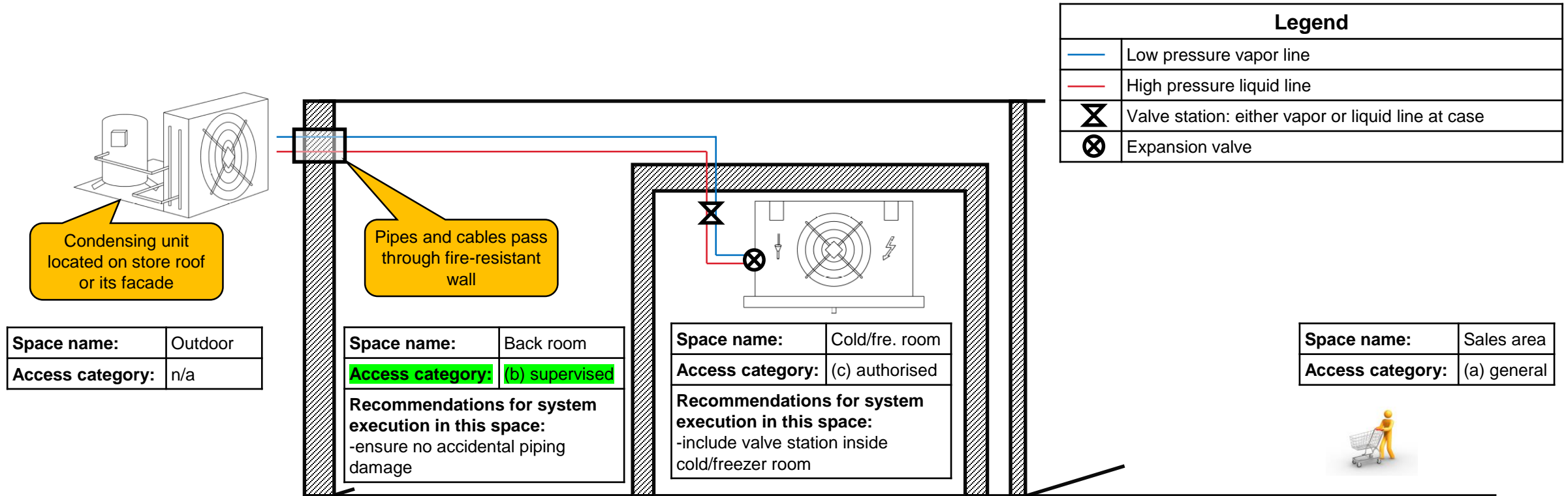

Criteria valid for charge size calculation

- Access category: (b) supervised
- System location: II

For refrigerant charge calculation, go to Chart 2 for R-455A / R-1234ze / R-1234yf

DISTRIBUTED SYSTEM „D“

INDOOR CONDENSING UNITS CONNECTED TO COLD/FREEZER ROOM



Space name:	Outdoor
Access category:	n/a

Space name:	Back room
Access category:	(b) supervised

Space name:	Cold/fre. room
Access category:	(c) authorised
Recommendations for system execution in this space:	
-include valve station inside cold/freezer room	

Space name:	Sales area
Access category:	(a) general

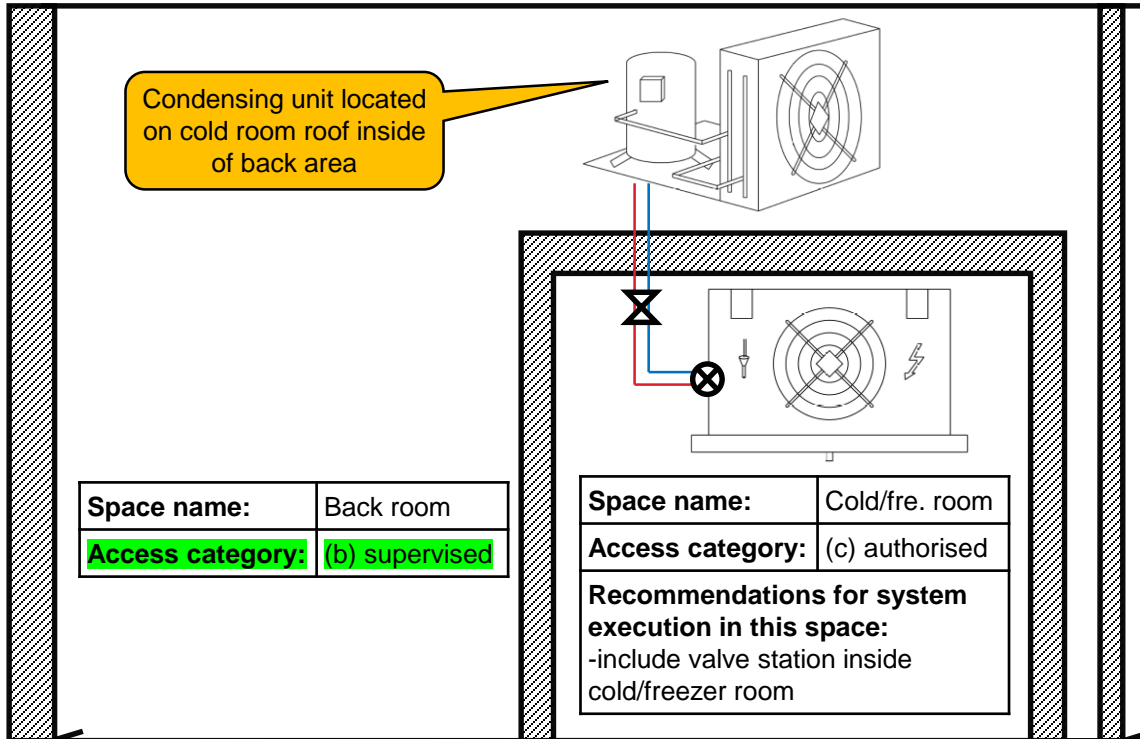

Legend	
	Low pressure vapor line
	High pressure liquid line
	Valve station: either vapor or liquid line at case
	Expansion valve



Criteria valid for charge size calculation

- Access category: (b) supervised
- System location: I

For refrigerant charge calculation, go to Chart 3 for R-455A / R-1234ze / R-1234yf

CENTRALIZED DX SYSTEM

WITH MACHINERY ROOM



Condenser located on store roof or its facade

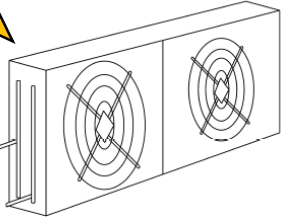

Space name:	Outdoor
Access category:	n/a

Criteria valid for charge size calculation

- Access category: (a) general
- System location: II

Legend	
	Low pressure vapor line
	High pressure liquid line
	High pressure vapor/condensate line
	Valve station: either vapor or liquid line at case
	Expansion valve

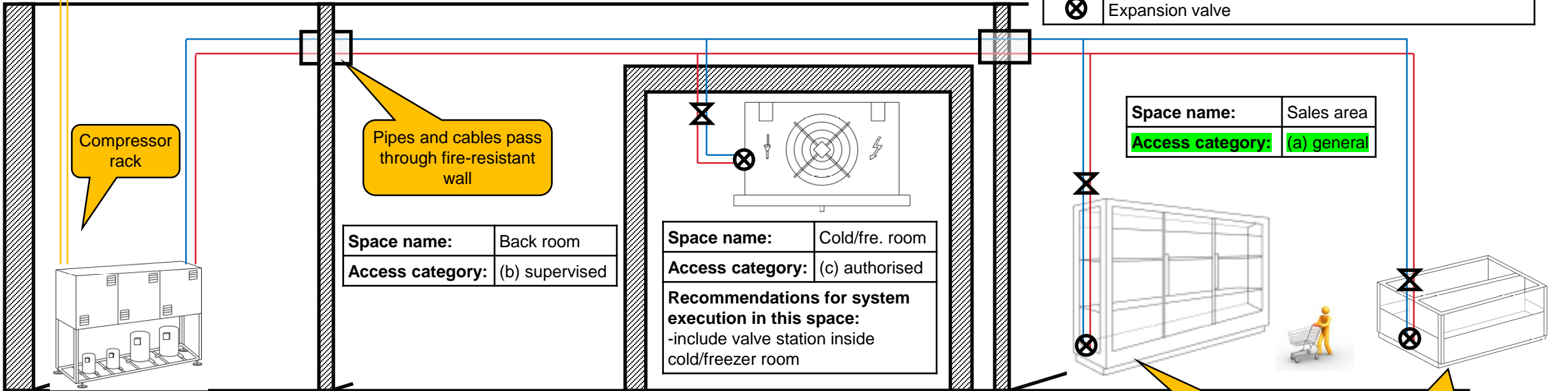

Compressor rack

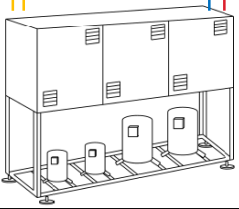

Pipes and cables pass through fire-resistant wall

Space name:	Back room
Access category:	(b) supervised

Space name:	Cold/fre. room
Access category:	(c) authorised

Recommendations for system execution in this space:
-include valve station inside cold/freezer room

Space name:	Sales area
Access category:	(a) general

Space name:	Machinery room
Access category:	(c) authorised
Recommendations for system execution in this space:	-see annex machinery room, EN-378:3

For refrigerant charge calculation, go to Chart 4 for R-455A / R-1234ze / R-1234yf

Multideck module (can be multiplied)

Island module (can be multiplied)

CENTRALIZED CASCADE SYSTEM „A“

WITH MACHINERY ROOM



Condenser located on store roof or its facade

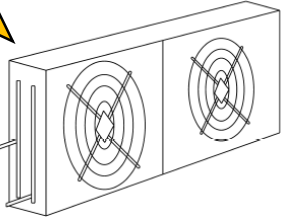

Space name:	Outdoor
Access category:	n/a

Criteria valid for charge size calculation

- Access category: (c) authorised
- System location: III

Legend	
	Low pressure vapor line: R-1234ze
	High pressure liquid line: R-1234ze
	High pressure vapor/condensate line: R-1234ze
	Low pressure vapor line: R-744
	High pressure liquid line: R-744
	Valve station: either vapor or liquid line at case
	Expansion valve

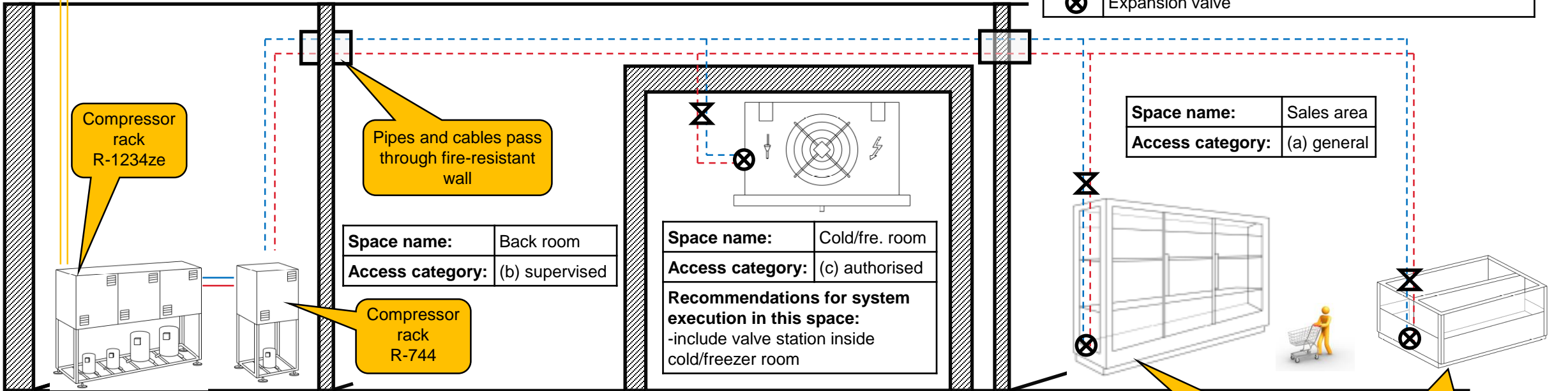

Space name:	Machinery room
Access category:	(c) authorised
Recommendations for system execution in this space: -see annex machinery room, EN-378:3	

For refrigerant charge calculation, go to Chart 5

CENTRALIZED CASCADE SYSTEM „B“

WITH MACHINERY ROOM | A2L REFRIGERANT IN DX

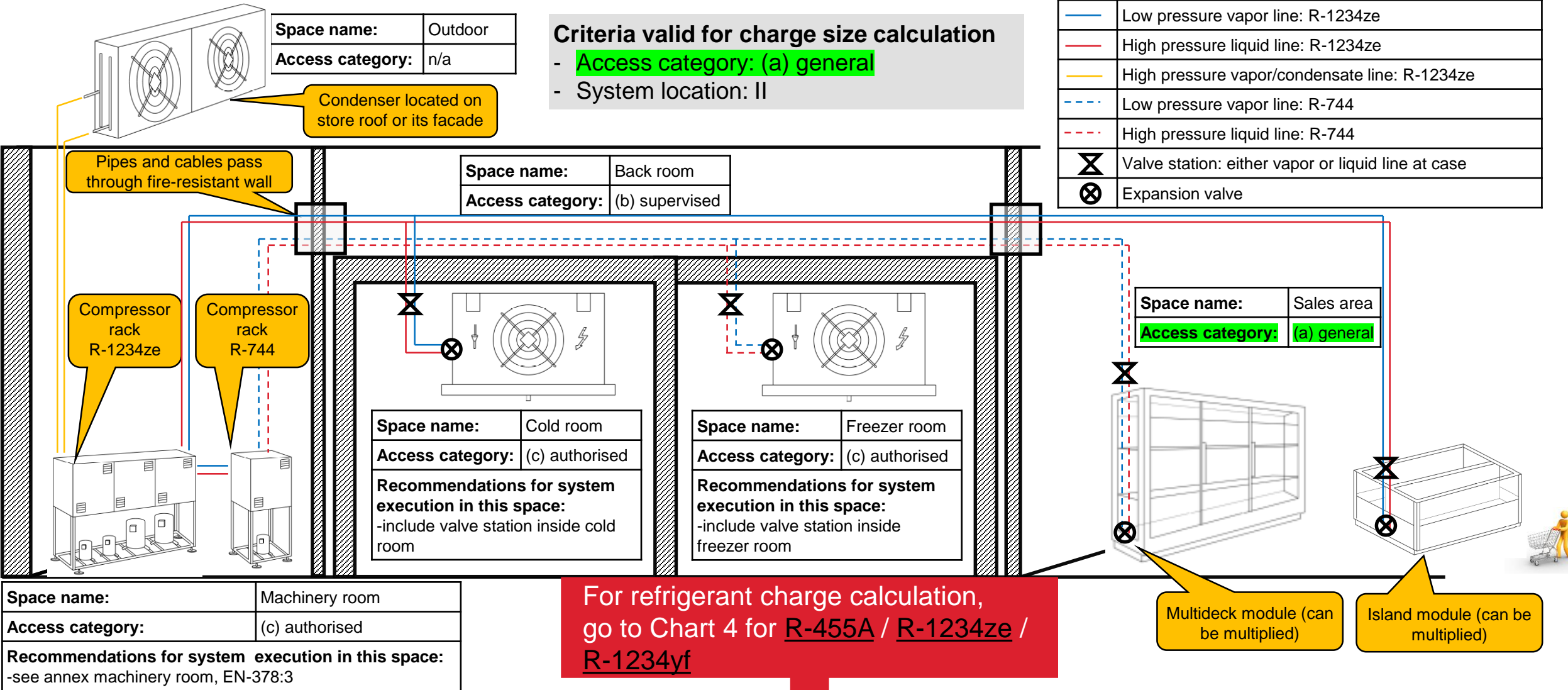

WATER LOOP SYSTEM WITH OUTDOOR DRY COOLER

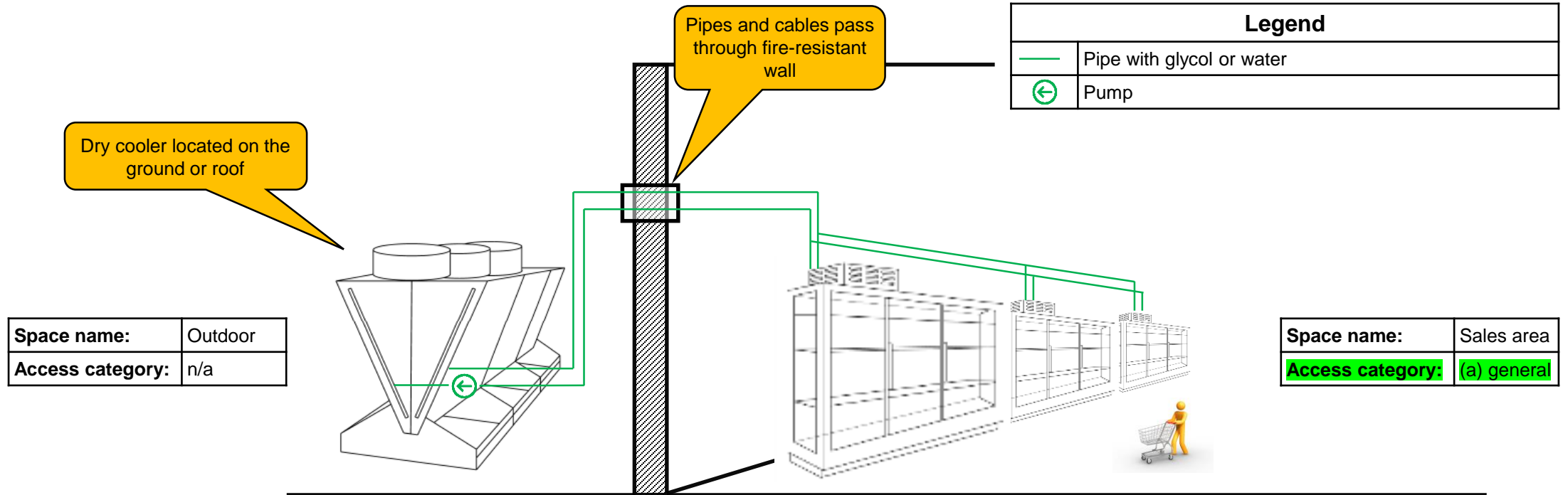

Criteria valid for charge size calculation

- Access category: (a) general
- System location: I

For refrigerant charge calculation,
go to Chart 3 for R-455A / R-1234ze /
R-1234yf

STAND-ALONE (PLUG-IN) SYSTEMS



Space name:	Outdoor
Access category:	n/a

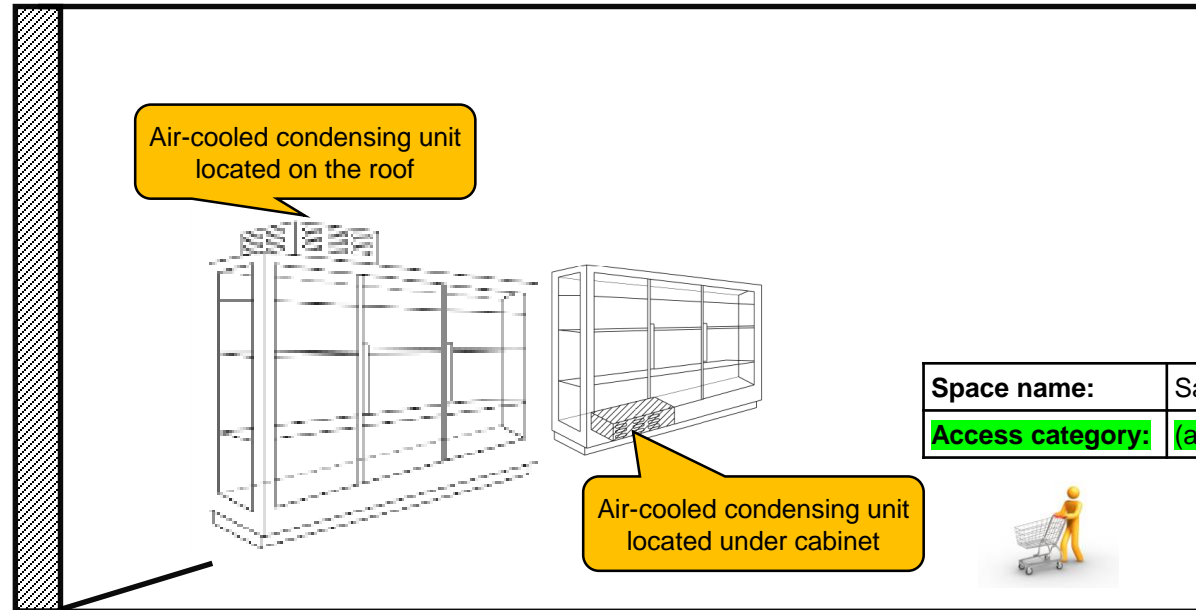

Space name:	Sales area
Access category:	(a) general

Criteria valid for charge size calculation

- Access category: (a) general
- System location: I

For refrigerant charge calculation, go to Chart 3 for R-455A / R-1234ze / R-1234yf

CHART 1 FOR REFRIGERANT R-455A

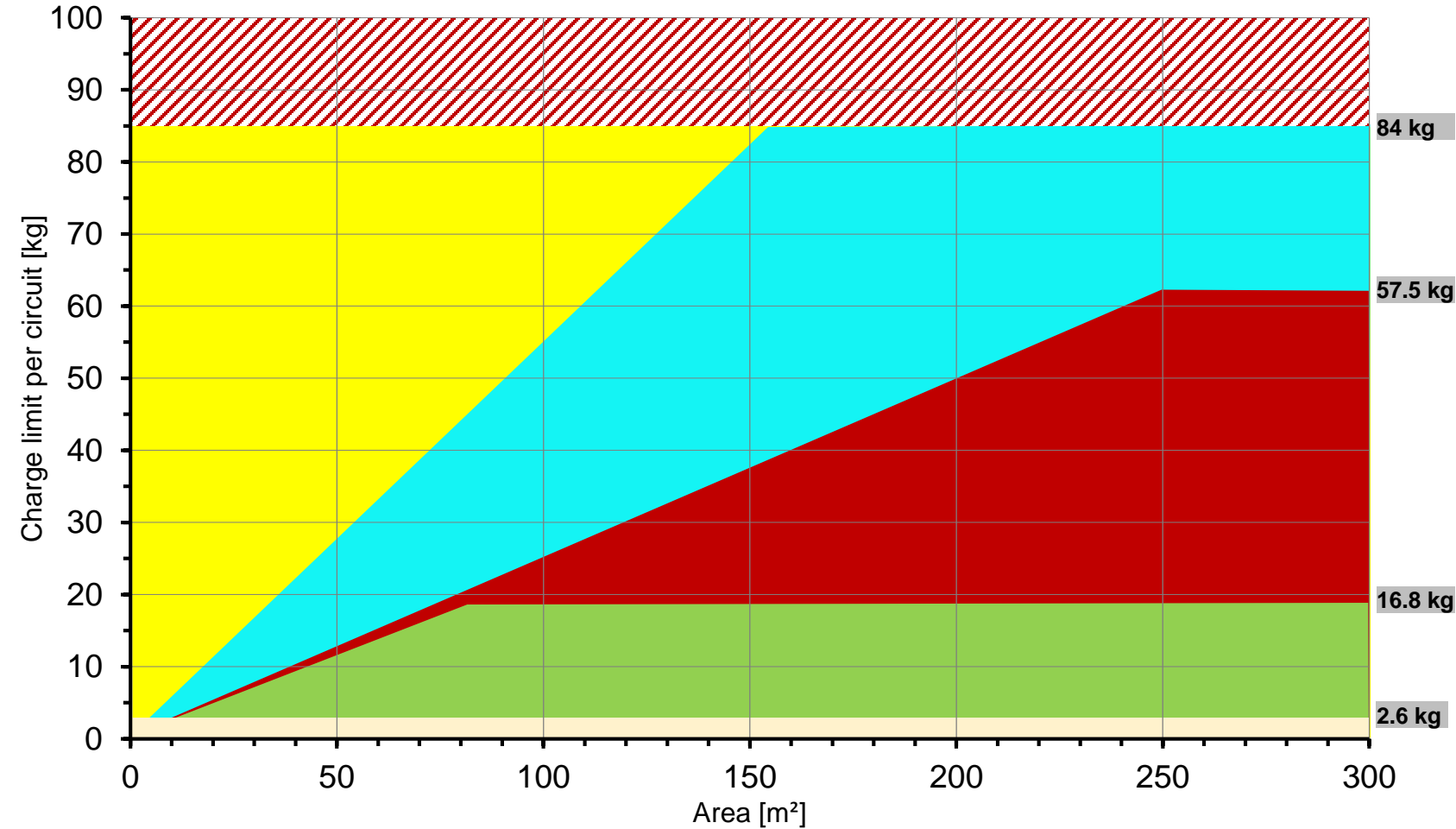

Room volume is calculated based on the ceiling height of 2.5m

Criteria valid for charge size calculation

- Access category: (a) general
- System location: II

- Charge range for a sealed system, no restrictions on room size
- Charge range for a standard system of a location II
- Charge range for a system of a location II, compliant with Annex C.3.
- Charge range for a system of a location II, compliant with Annex C.3. and with one safety measure applied
- Charge range for a system of a location II, compliant with Annex C.3. and with two safety measures applied
- Charge not allowed

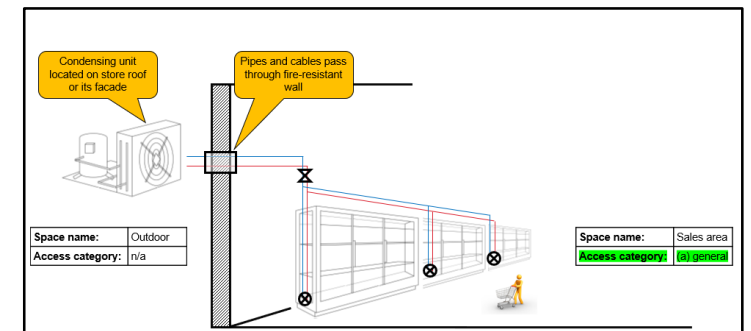
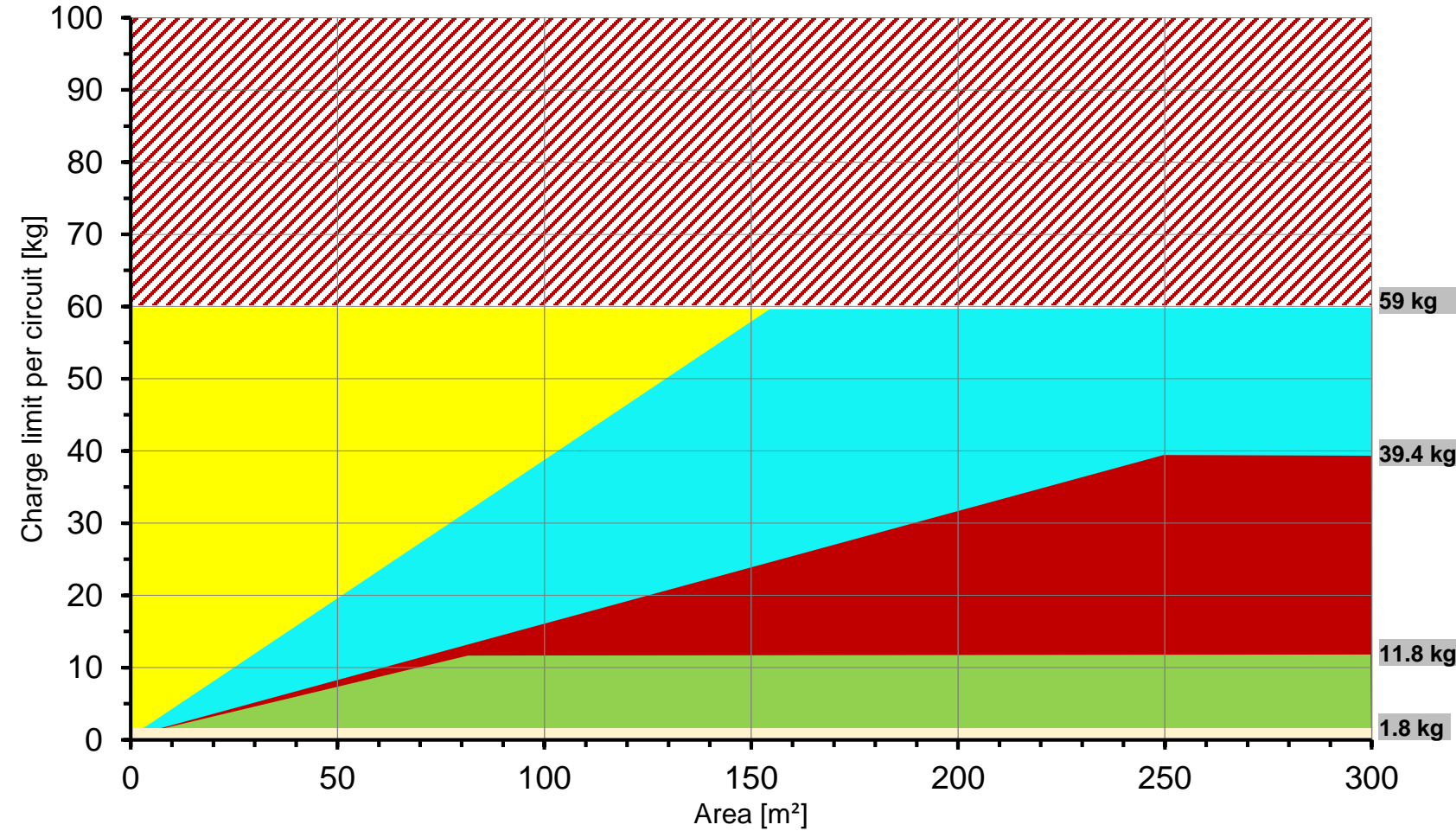

CHART 1 FOR REFRIGERANT R-1234ze



Room volume is calculated based on the ceiling height of 2.5m

Criteria valid for charge size calculation

- Access category: (a) general
- System location: II

- Charge range for a sealed system, no restrictions on room size
- Charge range for a standard system of a location II
- Charge range for a system of a location II, compliant with Annex C.3.
- Charge range for a system of a location II, compliant with Annex C.3. and with one safety measure applied
- Charge range for a system of a location II, compliant with Annex C.3. and with two safety measures applied
- Charge not allowed

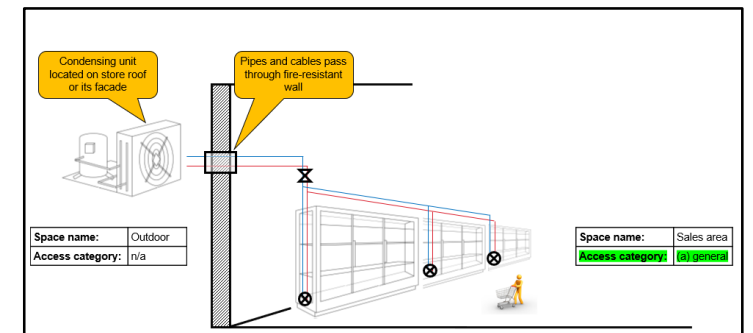
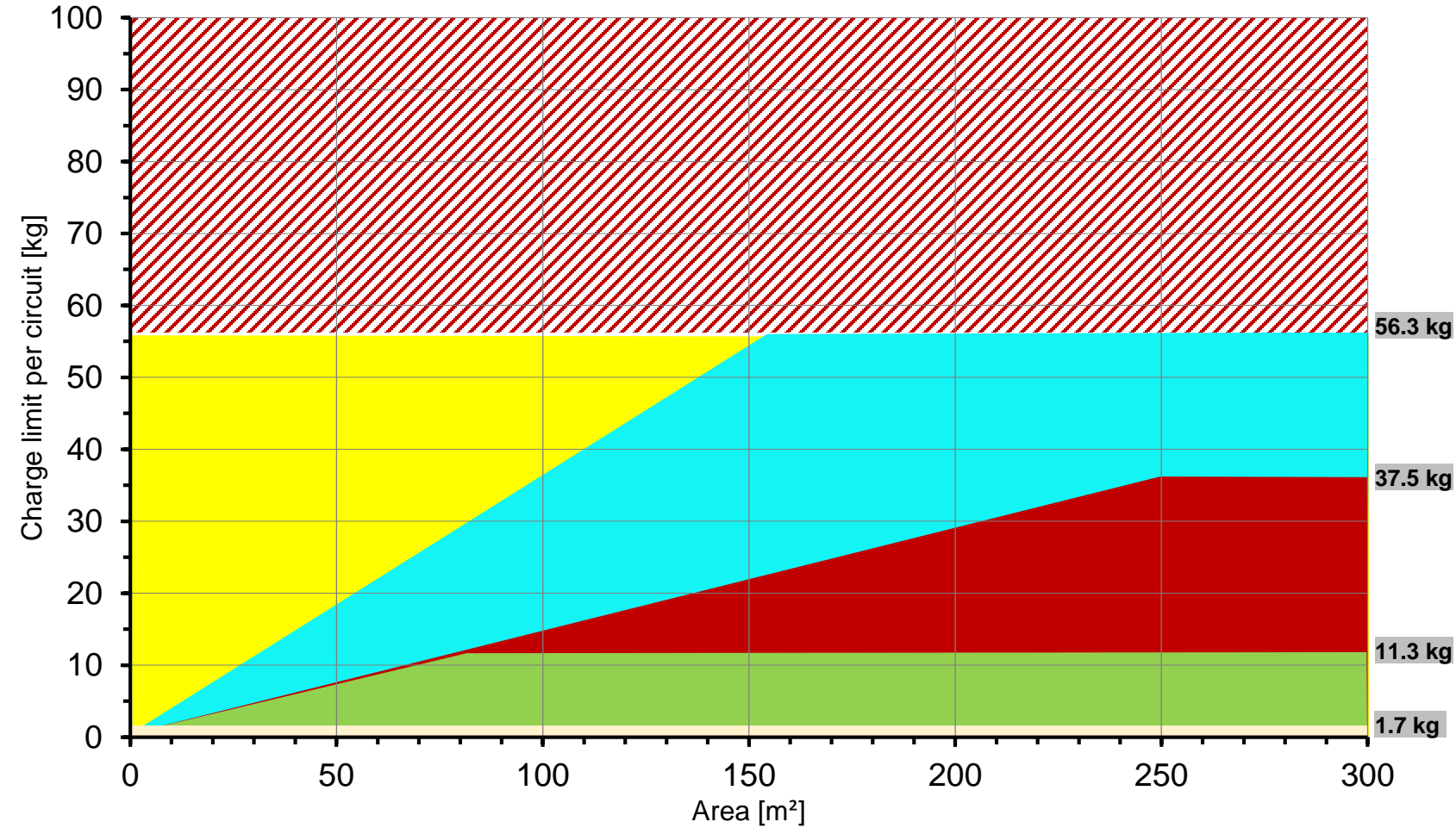

CHART 1 FOR REFRIGERANT R-1234yf



Room volume is calculated based on the ceiling height of 2.5m

Criteria valid for charge size calculation
 - Access category: (a) general
 - System location: II

- Charge range for a sealed system, no restrictions on room size
- Charge range for a standard system of a location II
- Charge range for a system of a location II, compliant with Annex C.3.
- Charge range for a system of a location II, compliant with Annex C.3. and with one safety measure applied
- Charge range for a system of a location II, compliant with Annex C.3. and with two safety measures applied
- Charge not allowed

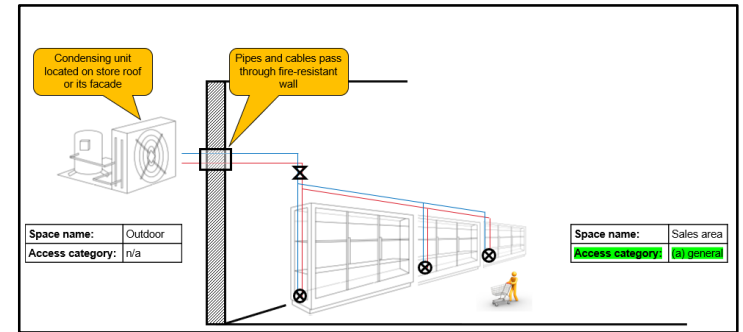
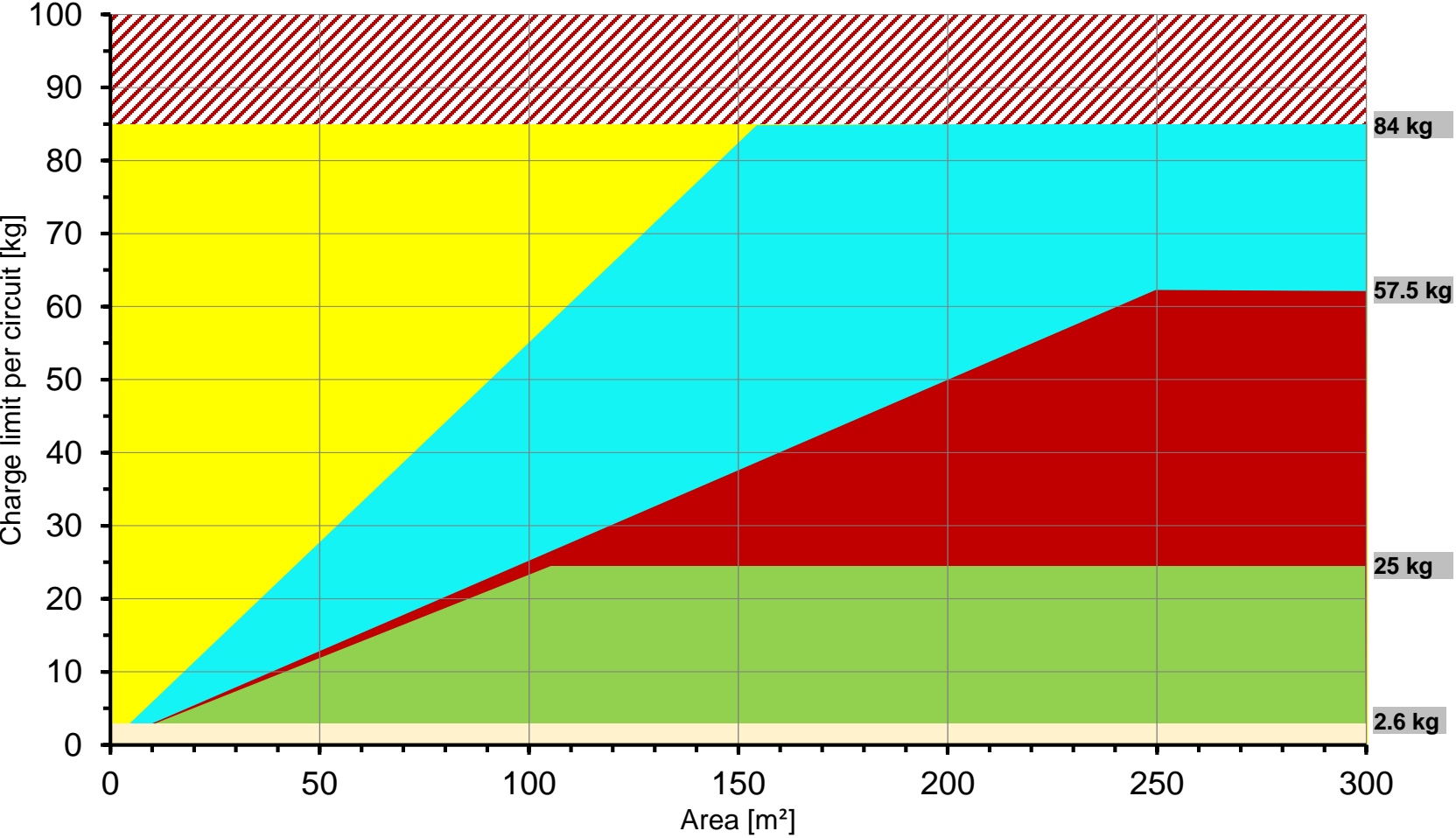

CHART 2 FOR REFRIGERANT R-455A



Criteria valid for charge size calculation

- Access category: (b) supervised
- System location: II

- Charge range for a sealed system, no restrictions on room size
- Charge range for a standard system of a location II
- Charge range for a system of a location II, compliant with Annex C.3.
- Charge range for a system of a location II, compliant with Annex C.3. and with one safety measure applied
- Charge range for a system of a location II, compliant with Annex C.3. and with two safety measures applied
- Charge not allowed

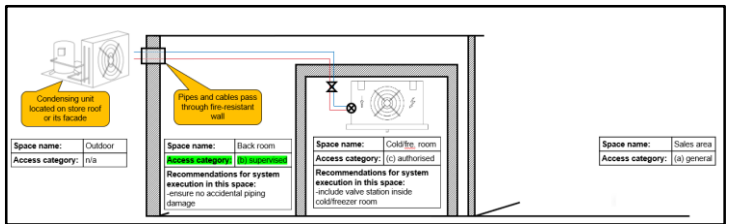

Room volume is calculated based on the ceiling height of 2.5m

CHART 2 FOR REFRIGERANT R-1234ze

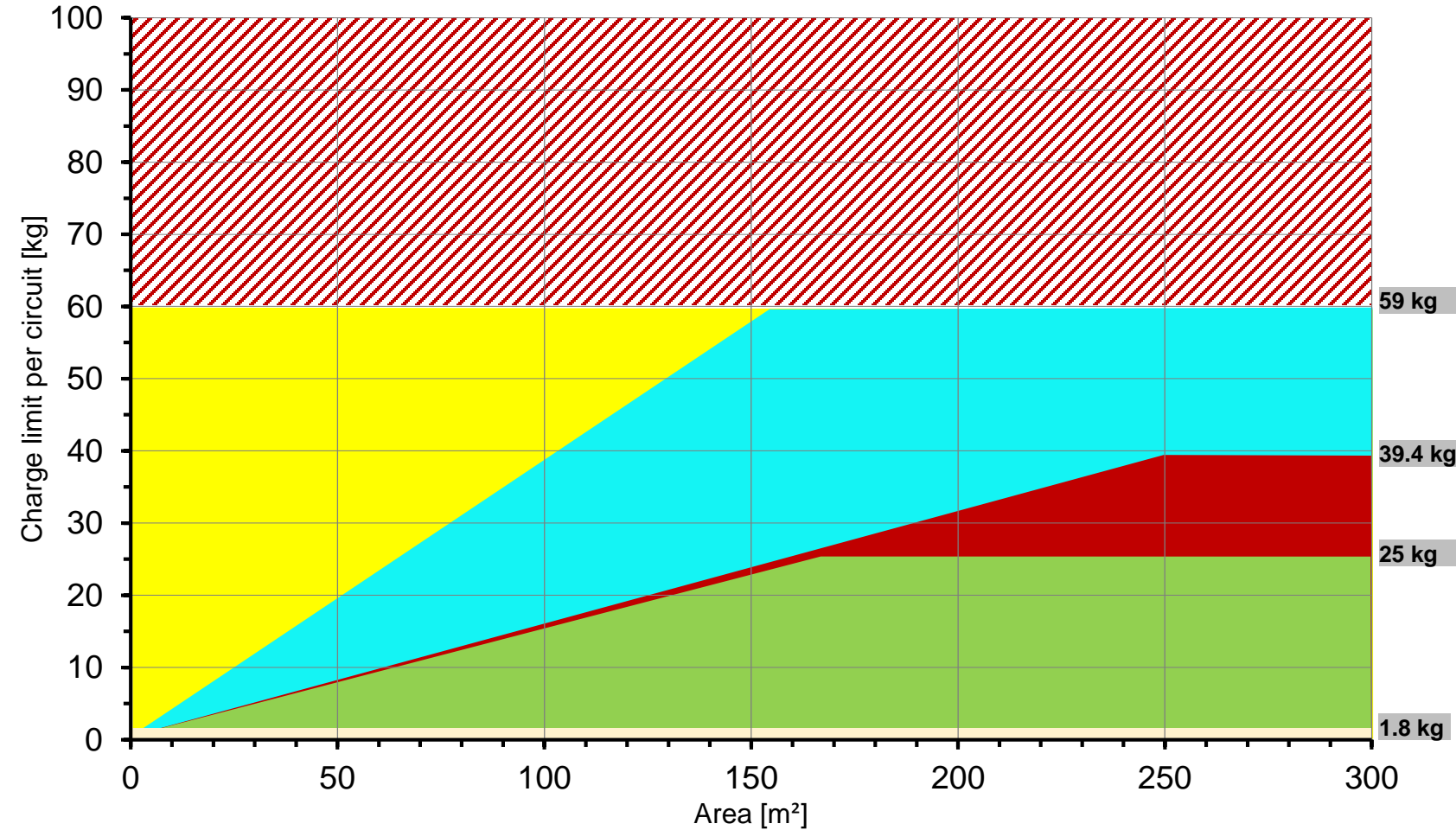

Criteria valid for charge size calculation

- Access category: (b) supervised
- System location: II

- Charge range for a sealed system, no restrictions on room size
- Charge range for a standard system of a location II
- Charge range for a system of a location II, compliant with Annex C.3.
- Charge range for a system of a location II, compliant with Annex C.3. and with one safety measure applied
- Charge range for a system of a location II, compliant with Annex C.3. and with two safety measures applied
- Charge not allowed

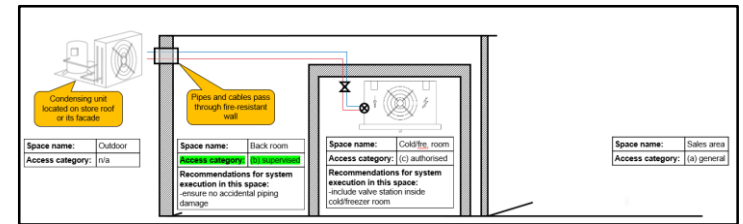

Room volume is calculated based on the ceiling height of 2.5m

CHART 2 FOR REFRIGERANT R-1234yf

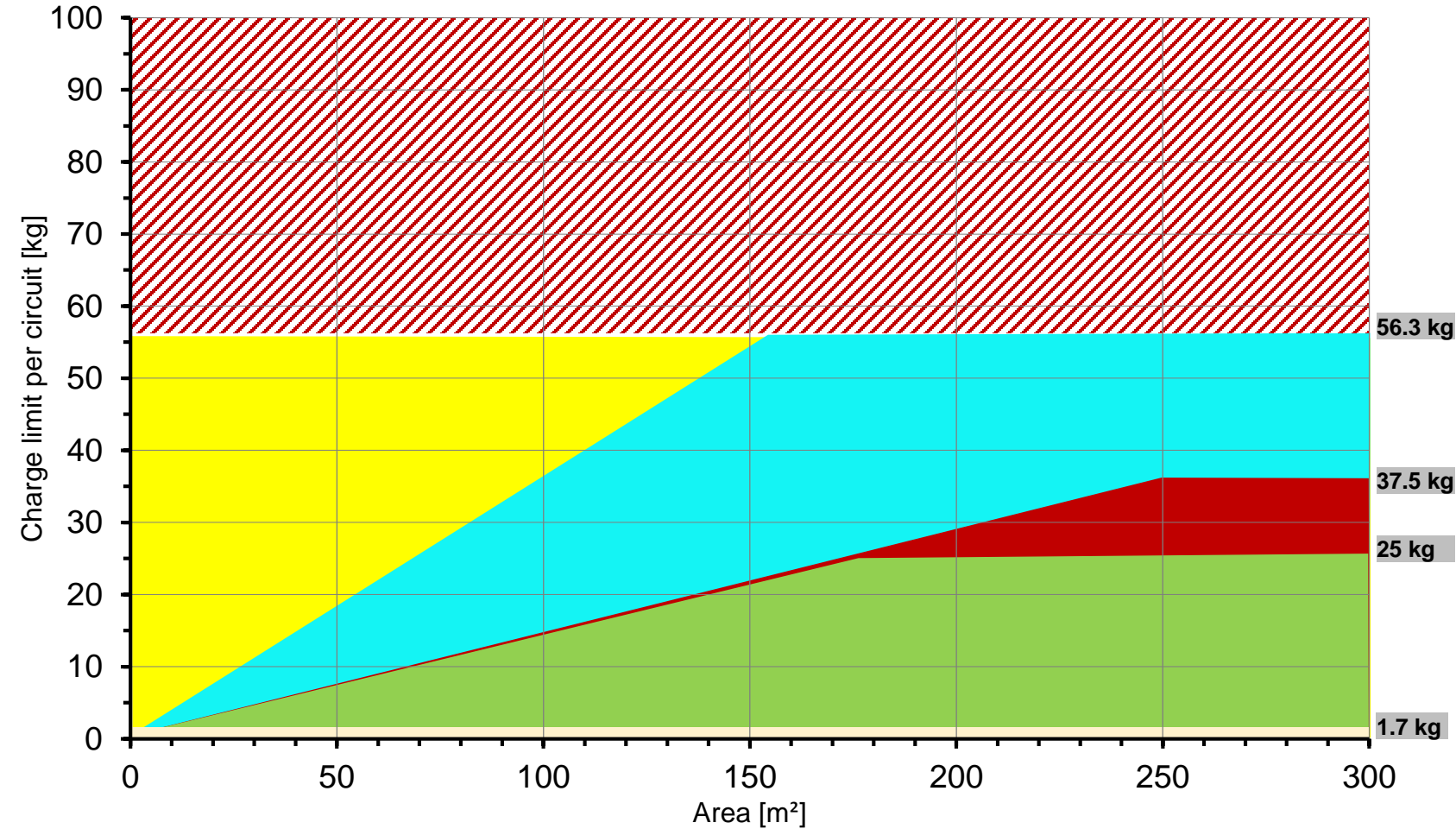

Criteria valid for charge size calculation

- Access category: (b) supervised
- System location: II

- Charge range for a sealed system, no restrictions on room size
- Charge range for a standard system of a location II
- Charge range for a system of a location II, compliant with Annex C.3.
- Charge range for a system of a location II, compliant with Annex C.3. and with one safety measure applied
- Charge range for a system of a location II, compliant with Annex C.3. and with two safety measures applied
- Charge not allowed

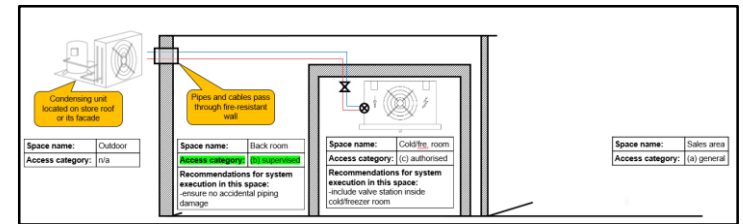

Room volume is calculated based on the ceiling height of 2.5m

CHART 3 FOR REFRIGERANT R-455A

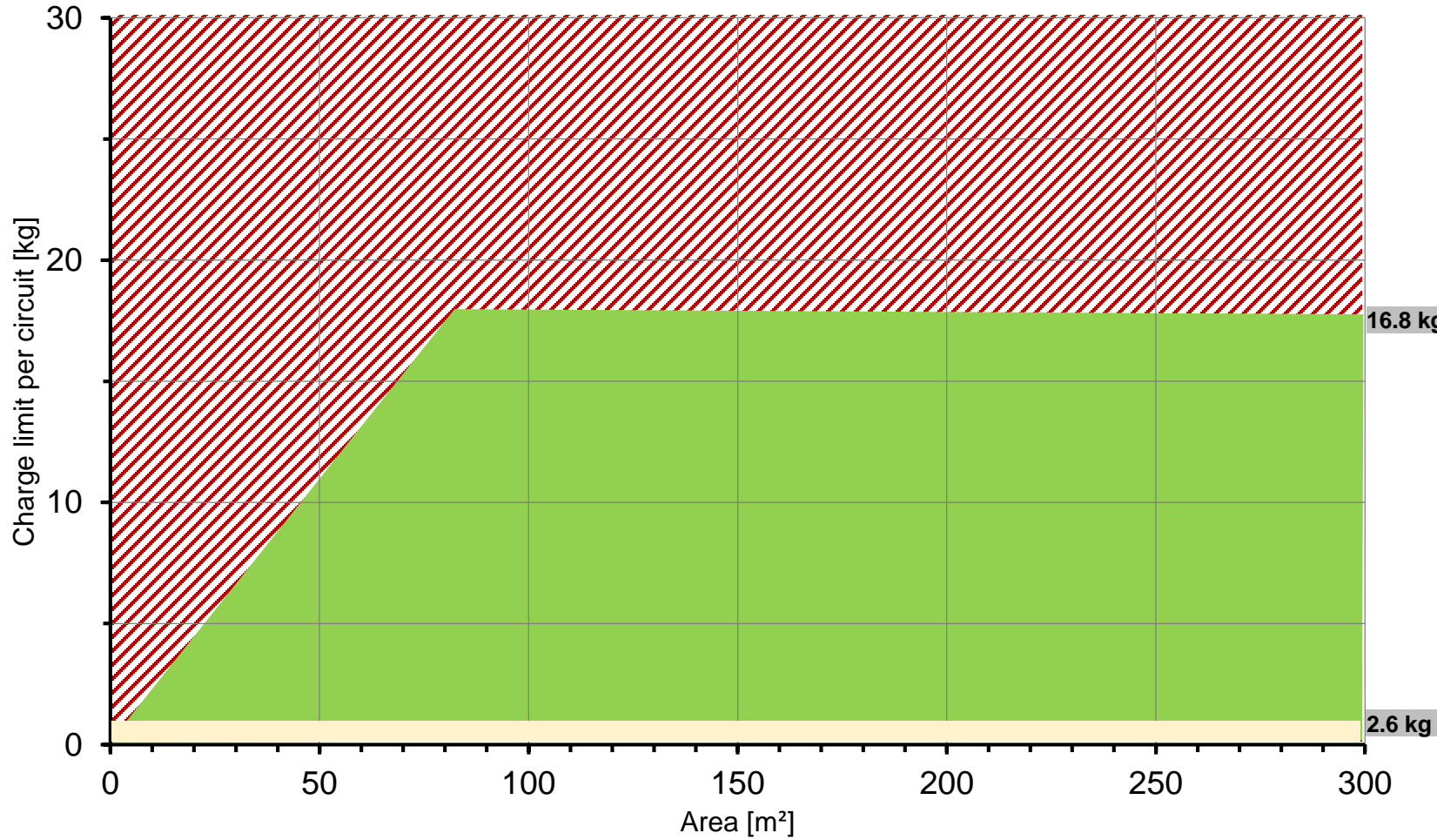

Room volume is calculated based on the ceiling height of 2.5m

Criteria valid for charge size calculation

- Access category: either (a) general or (b) supervised
- System location: I

- Charge range for a sealed system, no restrictions on room size
- Charge range for a standard system of a location I
- Charge not allowed

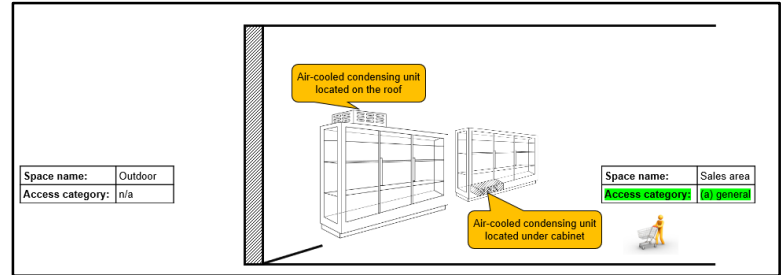
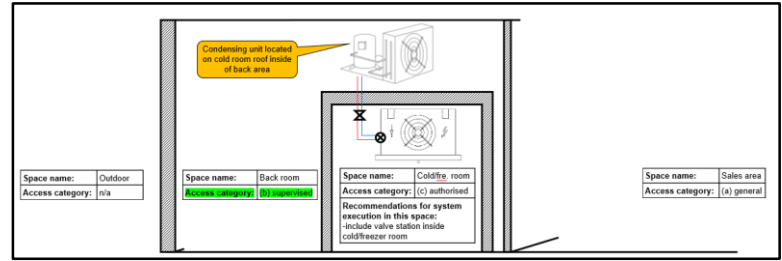
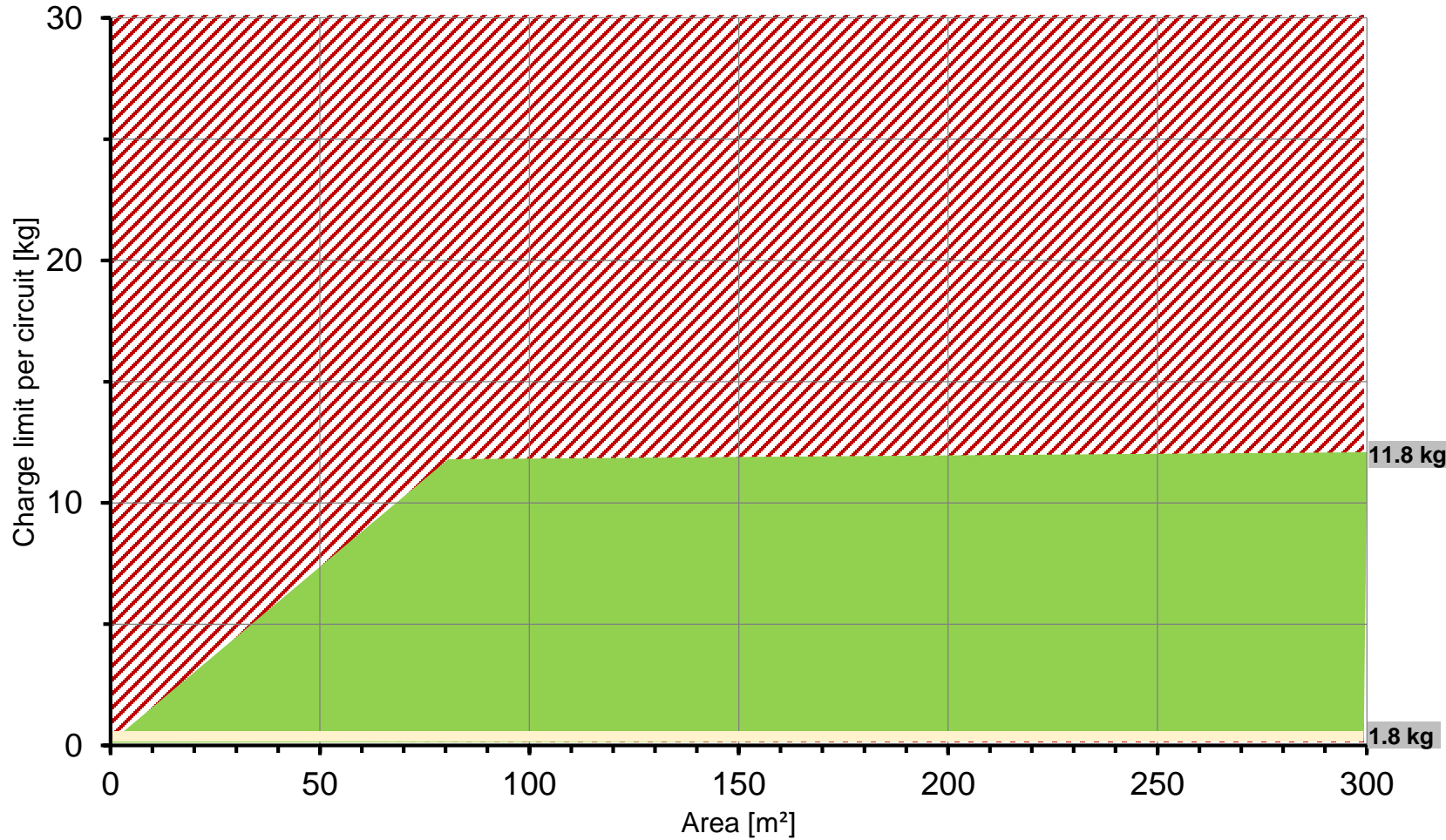

CHART 3 FOR REFRIGERANT R-1234ze



Room volume is calculated based on the ceiling height of 2.5m

Criteria valid for charge size calculation

- Access category: either (a) general or (b) supervised
- System location: I

- Charge range for a sealed system, no restrictions on room size
- Charge range for a standard system of a location I
- Charge not allowed

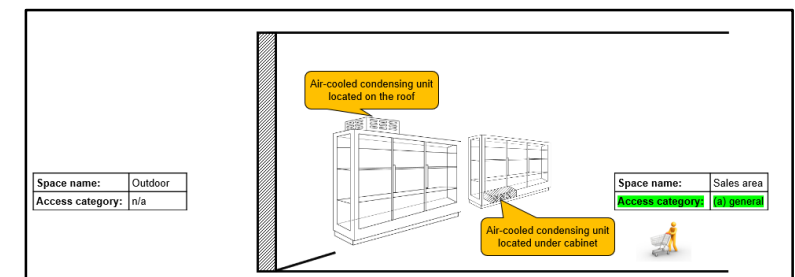
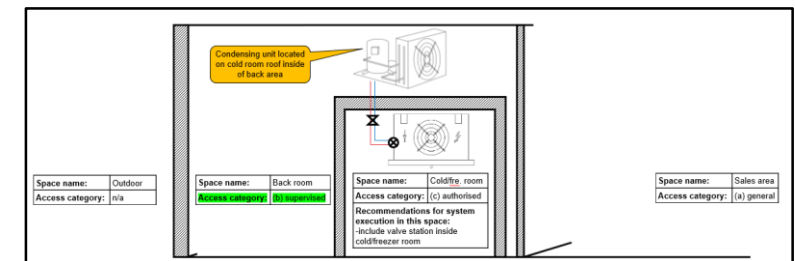
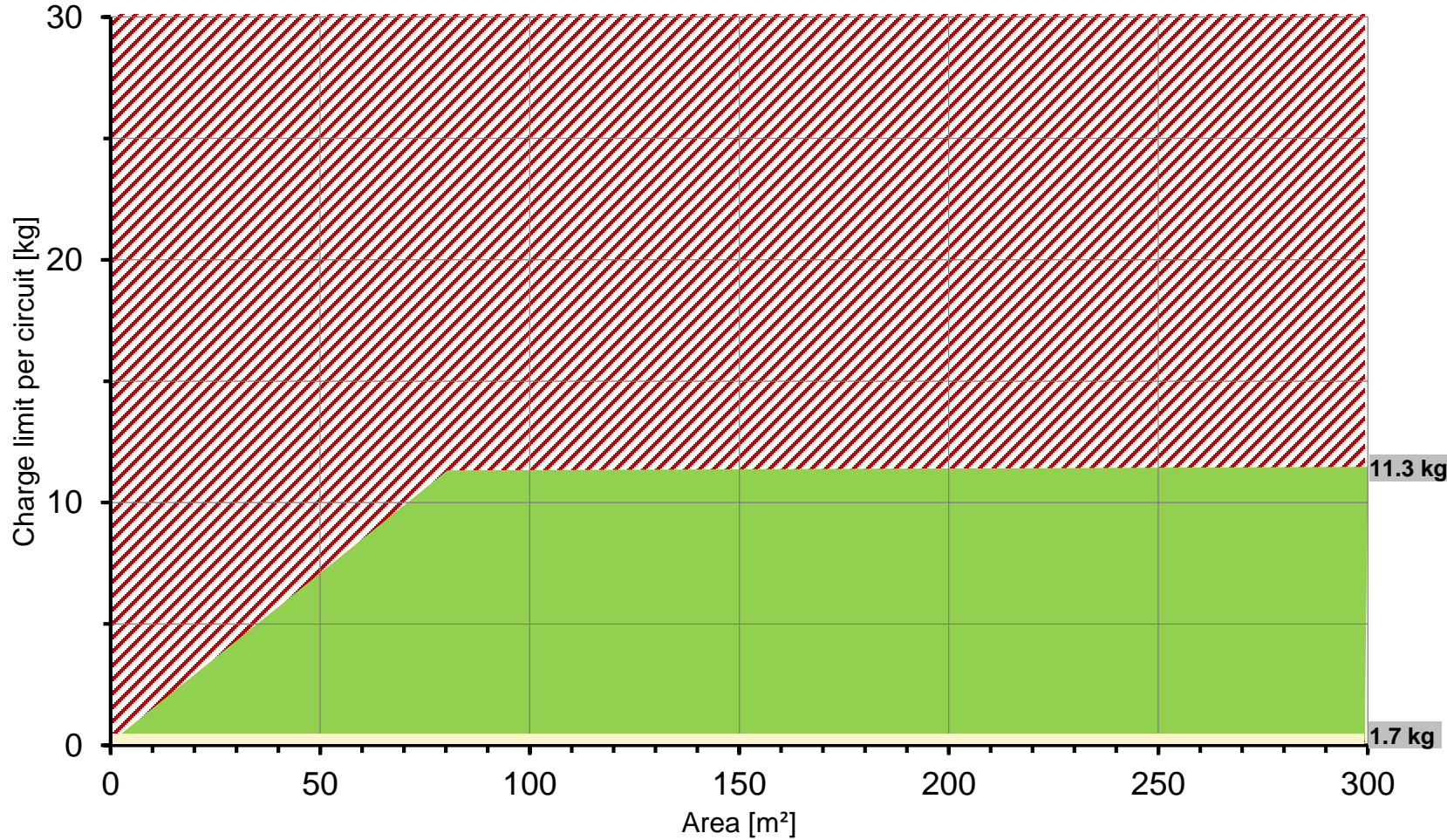

CHART 3 FOR REFRIGERANT R-1234yf



Room volume is calculated based on the ceiling height of 2.5m

Criteria valid for charge size calculation

- Access category: either (a) general or (b) supervised
- System location: I

- Charge range for a sealed system, no restrictions on room size
- Charge range for a standard system of a location I
- Charge not allowed

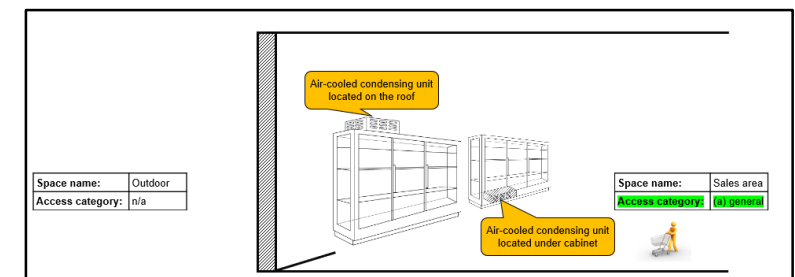
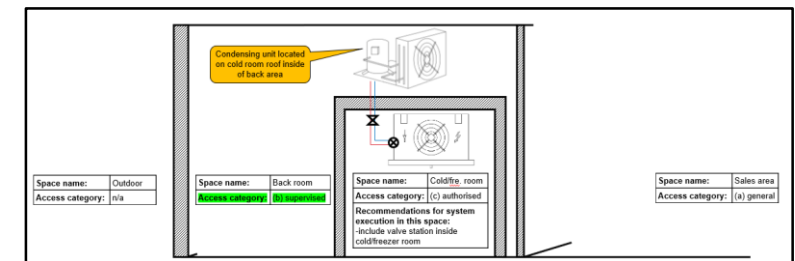
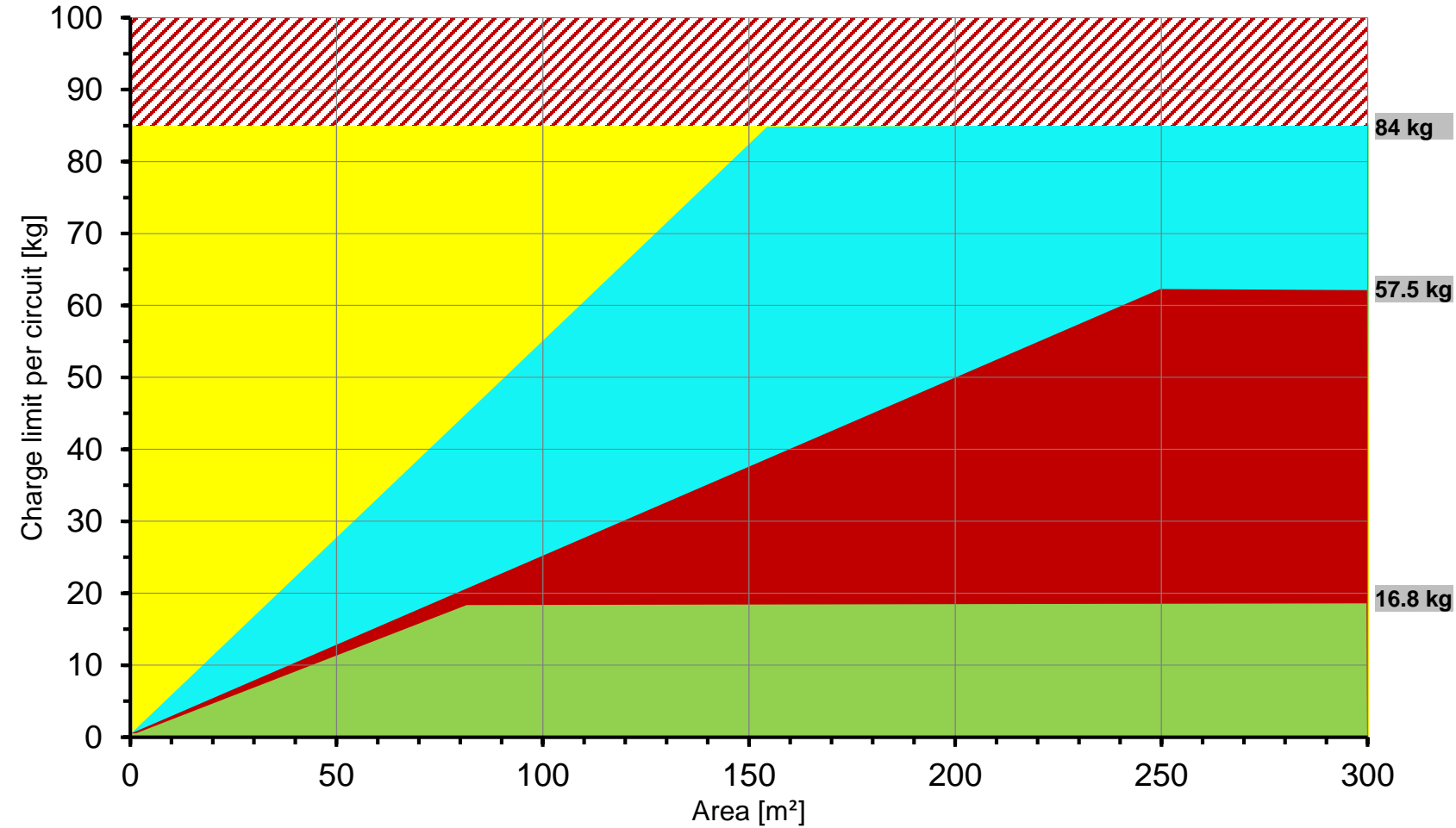

CHART 4 FOR REFRIGERANT R-455A



Criteria valid for charge size calculation

- Access category: (a) general
- System location: II

- Charge range for a standard system of a location II
- Charge range for a system of a location II, compliant with Annex C.3.
- Charge range for a system of a location II, compliant with Annex C.3. and with one safety measure applied
- Charge range for a system of a location II, compliant with Annex C.3. and with two safety measures applied
- Charge not allowed

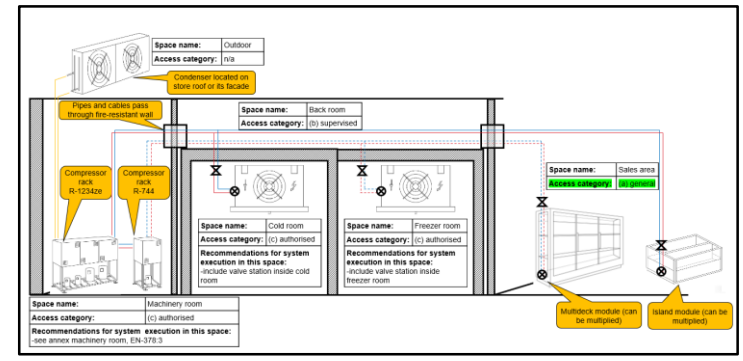

Room volume is calculated based on the ceiling height of 2.5m

CHART 4 FOR REFRIGERANT R-1234ze

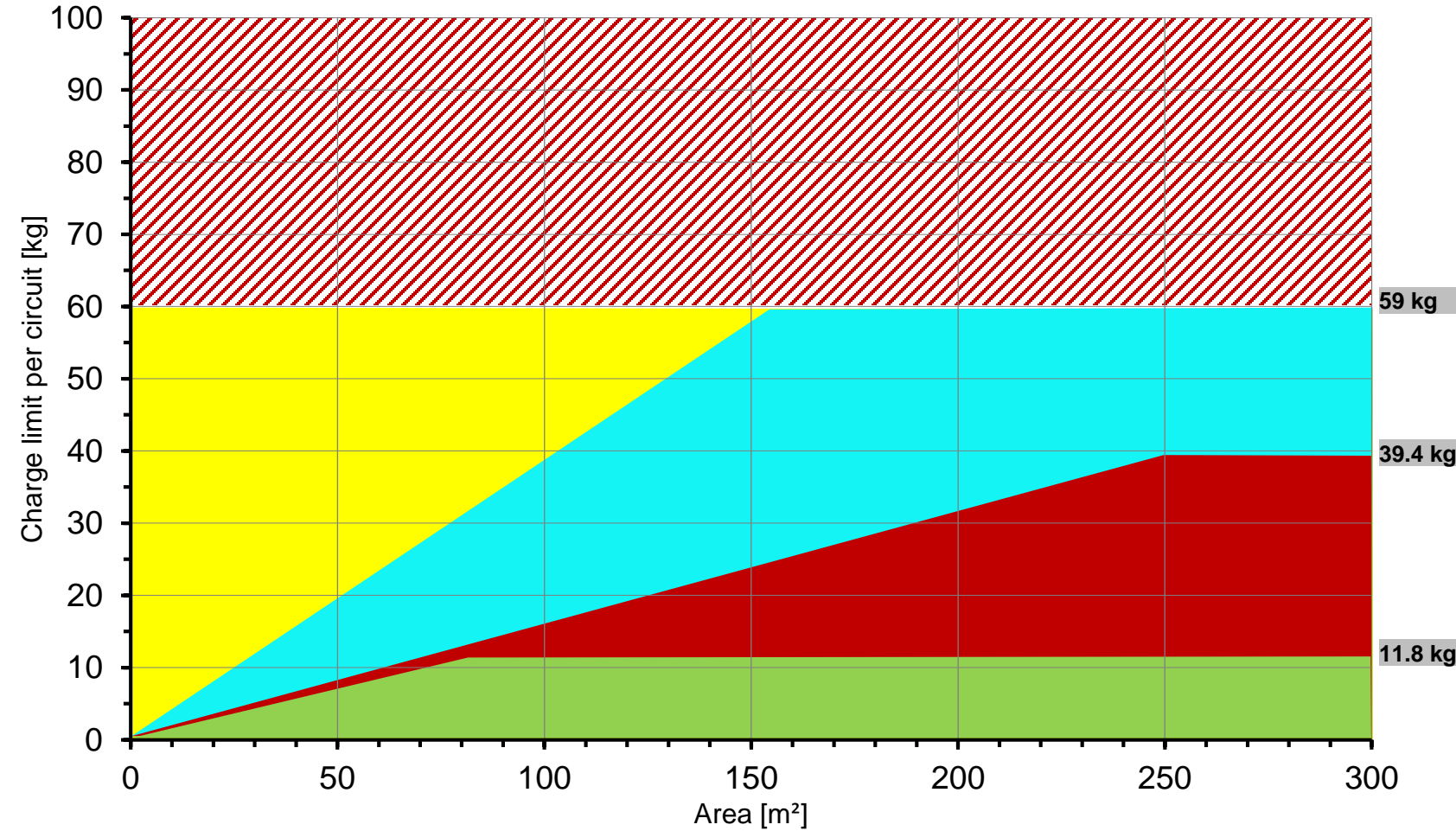

Criteria valid for charge size calculation
 - Access category: (a) general
 - System location: II

- Charge range for a standard system of a location II
- Charge range for a system of a location II, compliant with Annex C.3.
- Charge range for a system of a location II, compliant with Annex C.3. and with one safety measure applied
- Charge range for a system of a location II, compliant with Annex C.3. and with two safety measures applied
- Charge not allowed

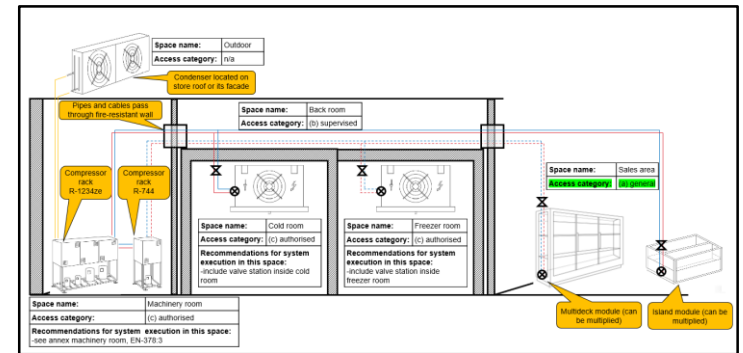

Room volume is calculated based on the ceiling height of 2.5m

CHART 4 FOR REFRIGERANT R-1234yf

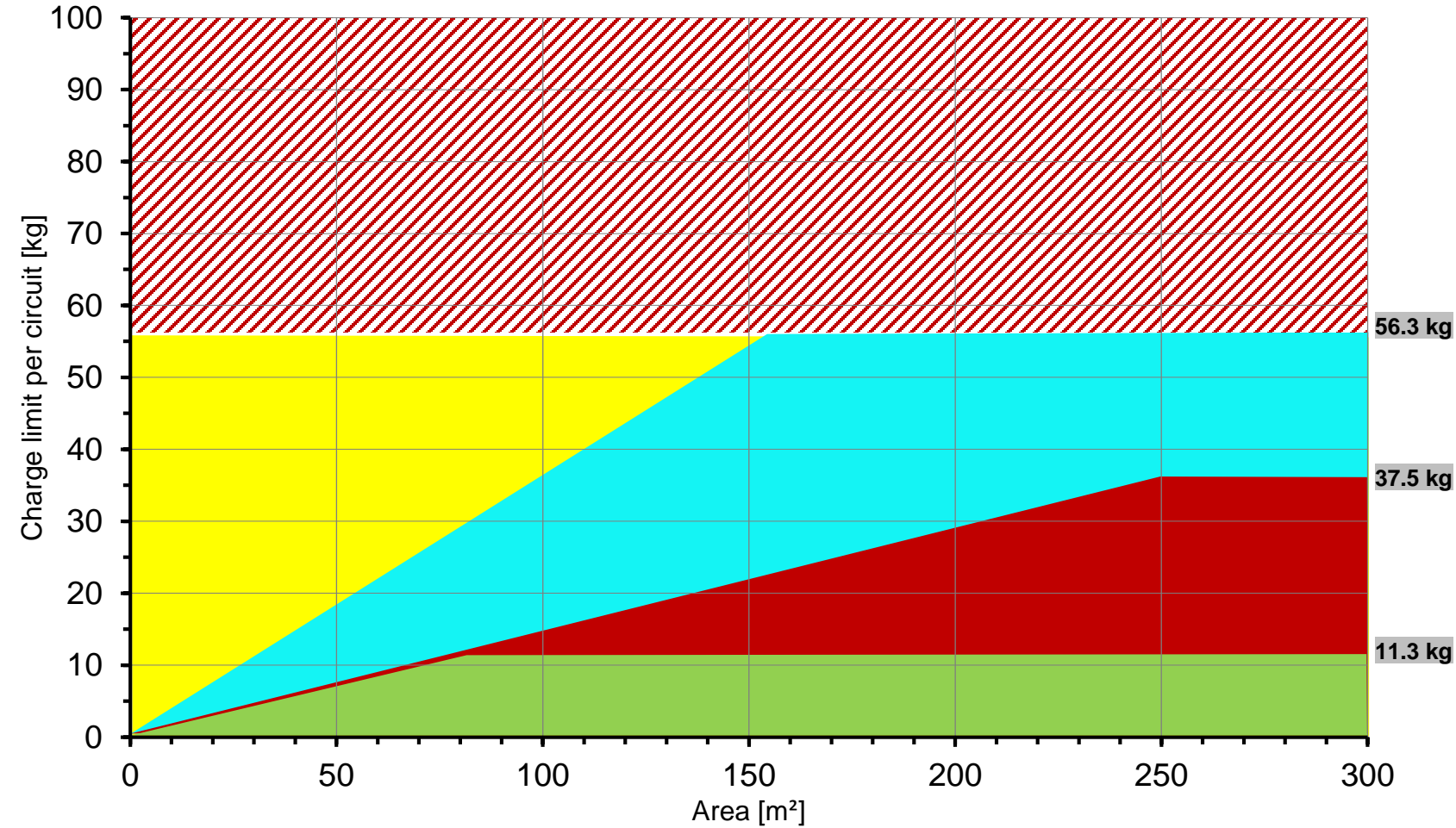

Criteria valid for charge size calculation
 - Access category: (a) general
 - System location: II

- Charge range for a standard system of a location II
- Charge range for a system of a location II, compliant with Annex C.3.
- Charge range for a system of a location II, compliant with Annex C.3. and with one safety measure applied
- Charge range for a system of a location II, compliant with Annex C.3. and with two safety measures applied
- Charge not allowed

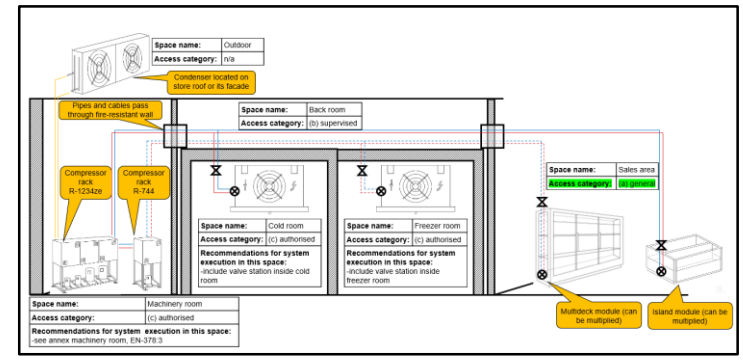

Room volume is calculated based on the ceiling height of 2.5m

CHART 5 FOR R-455A, R-1234ze, R-1234yf

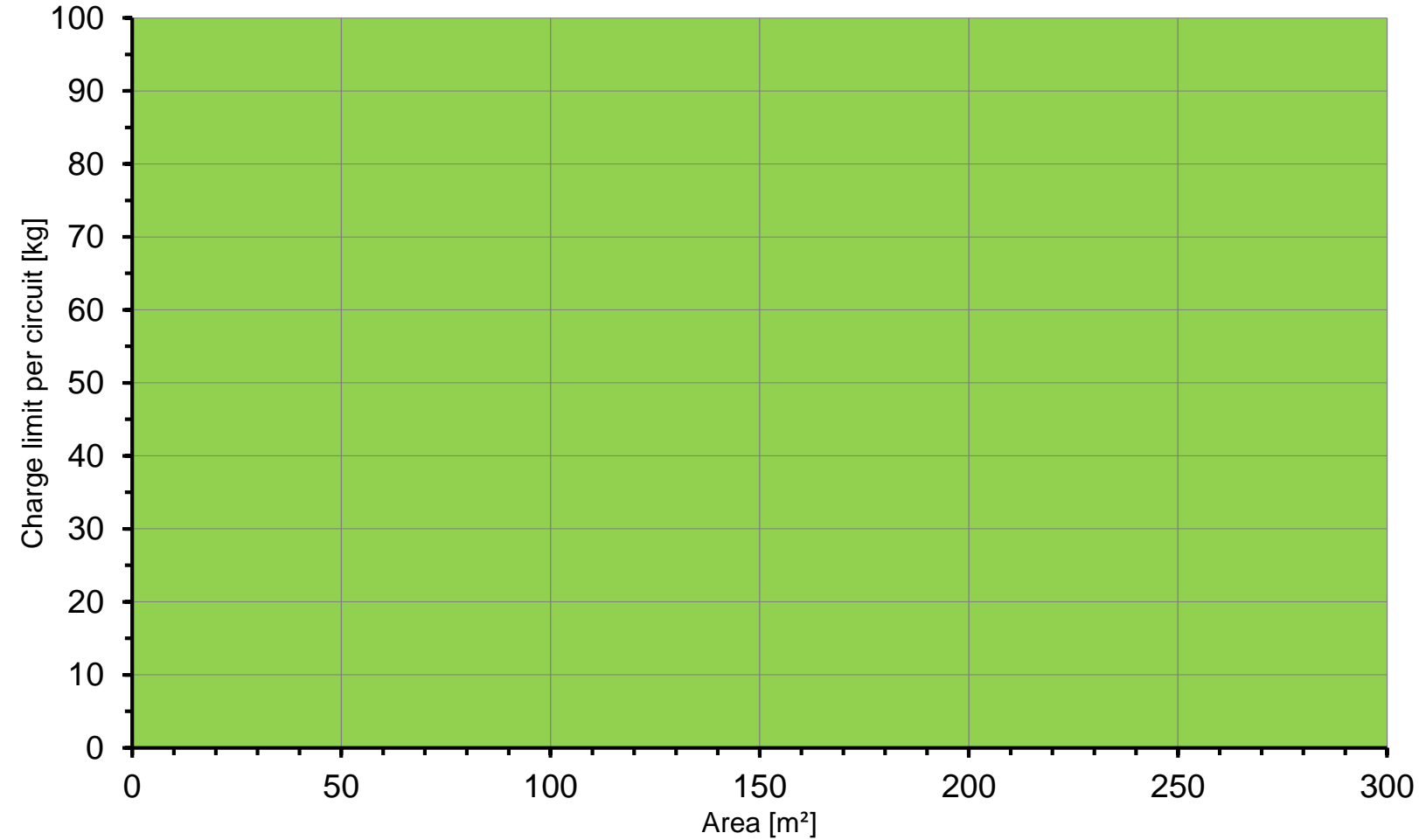

Criteria valid for charge size calculation
 - Access category: (c) authorised
 - System location: III

No charge restrictions, machinery room requirement EN378 art 3, 5.1

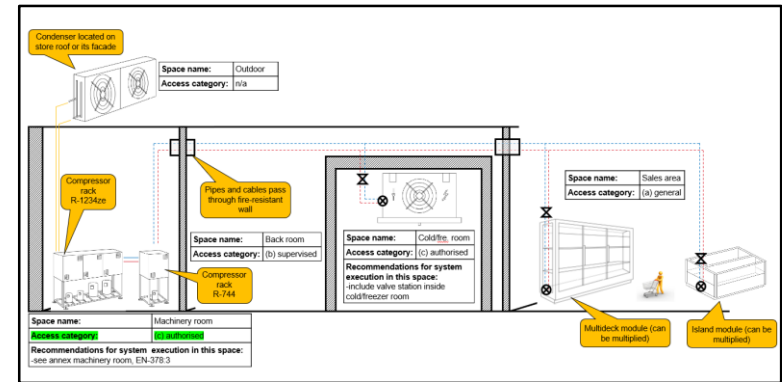

Room volume is calculated based on the ceiling height of 2.5m

ADDITIONAL CONSIDERATIONS FOR RISK ASSESSMENT AND MITIGATION



Apart from the charge size calculation, you need to ensure proper execution of the **machinery room** (if any) and **electrical supply**. We also added some considerations around the **PED requirements** when using A2L refrigerants.

MACHINERY ROOM FOR A2L



- Refer to EN 378, Part 3, Section 5.14 for more details.
- The machinery room shall be located in accordance with local and national regulations.
- Machinery rooms with group A2L, A2, B2L, B2, A3, B3 refrigerants shall be assessed with regard to flammability and classified according to the requirements of EN 60079-10-1 for the hazardous zone.
- The assessment according to EN 60079-10-1 considering the LFL and type of release may conclude that the hazardous area is of negligible extent.
- Door to machinery room should be clearly marked with:
 - No access for unauthorized personnel
 - Smoking and open flame prohibited
 - Unauthorized operation of the refrigeration system is prohibited
- A notice indicating the procedures to be adopted in the event of an alarm shall be clearly visible within the occupied space.
- Open flames shall not be permitted in machinery rooms, except when the refrigerant concentration is monitored and adequate ventilation is ensured.
- Walls, floor and ceiling between the machinery room and the rest of the building shall have at least a one hour fire resistive construction and be tightly sealed.
- There shall be no openings that permit unintended passage of escaping refrigerant, vapors, odors and all other gases to any occupied space.
- Machinery rooms shall not be used for storage with the exception of tools, spare parts and compressor oil.
- Air supply for combustion equipment or air compressors shall ducted from outside.
- The doors shall be tight fitting and self-closing, and have at least a one-hour fire resistance construction.
- Exterior openings shall not be situated within 2 meter of building emergency exit staircases or other building openings, e.g. windows, doors, ventilation inlets. At least one emergency exit shall open directly to the open air or it shall lead to an emergency exit passageway.

ELECTRICAL SUPPLY



- The general electrical installation of the refrigerating and other equipment including lighting, power etc. shall conform to national regulations and the provisions in IEC 60364 series as appropriate.
- The electrical power supply to a refrigerating system shall be electrically arranged so that it can be switched off independently of the electricity supply to other electrical equipment in general and, in particular, to any lighting system, ventilation unit, alarm and other safety equipment. The connection of the main power supply to the refrigerating machinery shall be in accordance with EN 60204-1:2006, Clauses 4 and 5.
- Electrical equipment shall be selected to be suitable for use in the zones identified in Clause 5.14.1.
- For 2L refrigerants, electrical equipment shall be deemed to comply with the requirements if the electrical supply is isolated when the refrigerant concentration reaches 25% of the lower flammable limit or less. Equipment which remains live in the event of the refrigerant concentration exceeding the main alarm level, for example alarms, gas detectors, ventilation fans and emergency lighting, shall be suitable for operation in a hazardous area.

PED CONSIDERATIONS FOR A2L REFRIGERANTS

- Referring to system components sourced from OEMs, make sure that these are qualified for the correct PED group category of the fluid. **For piping and connecting systems, it is the responsibility of the contractor to conduct PED rating (see the following 2 slides).** Refer to PED directive for comprehensive design procedures (module etc.).
- The EU Pressure Equipment Directive (PED) sets requirements for the verification of the pressure strength of components depending on the PED category, which is a function of the size, the maximum allowable pressure of the component, and the PED fluid group of the refrigerant (1 or 2). The higher the PED category, the higher the expected risk, and the higher the requirements for verification of design and production of components. The directive has 5 categories, sound engineering (practice), I, II, III and IV.
- Most flammable refrigerants are gasses in PED fluid group 1 (hazardous substances). There is however an exception, R-1234ze(E) is in PED fluid group 2 despite the safety classification A2L. The reason for this exception is that the flammability test behind the PED fluid group classification is done at 20°C, while the flammability test behind the A2L safety classification is done at 60°C. R-1234ze(E) is not flammable at 20°C, but it is flammable at 60°C.
- The EN 378 Part 2 (“Design, construction, testing, marking and documentation”) is harmonized with the Pressure Equipment Directive (PED 2014/68/EU). Harmonization means that compliance with specific clauses of the standard can be presumed to indicate conformity with the equivalent essential safety requirements of the directive.

PED FOR PIPING: R-455A / R-1234YF



Pipe	Outer Diameter	DN equivalent	PED requirement for suction line , piping is protected form exceeding PS=16 bar by safety valve	PED requirement for liquid, discharge, condensate lines , piping is protected form exceeding PS=28 bar by safety valve
[-]	[mm]	[dimensionless]	[-]	[-]
Copper pipe 10 x 1 mm	10	6	Sound engineering practice, same as for A1 refrigerants	Sound engineering practice, same as for A1 refrigerants
Copper pipe 12 x 1 mm	12	8	Sound engineering practice, same as for A1 refrigerants	Sound engineering practice, same as for A1 refrigerants
Copper pipe 15 x 1 mm	15	10	Sound engineering practice, same as for A1 refrigerants	Sound engineering practice, same as for A1 refrigerants
Copper pipe 18 x 1 mm	18	10	Sound engineering practice, same as for A1 refrigerants	Sound engineering practice, same as for A1 refrigerants
Copper pipe 22 x 1 mm	22	15	Sound engineering practice, same as for A1 refrigerants	Sound engineering practice, same as for A1 refrigerants
Copper pipe 28 x 1,5 mm	28	20	Sound engineering practice, same as for A1 refrigerants	Sound engineering practice, same as for A1 refrigerants
Copper pipe 35 x 1,5 mm	35	25	Sound engineering practice, same as for A1 refrigerants	Sound engineering practice, same as for A1 refrigerants
Copper pipe 42 x 1,5 mm	42	32	Module A needs to be applied while assembling line	Module A needs to be applied while assembling line
Copper pipe 54 x 2 mm	54	40	Module A needs to be applied while assembling line	Higher modules (A2, D1, E1)
Copper pipe 64x 2 mm	64	50	Module A needs to be applied while assembling line	Higher modules (A2, D1, E1)

The term “Module...” refers to set of procedures to follow in order to ensure conformity with PED requirements while assembling piping on site:

- Module A sets procedures that can be handled by the contractor alone.
- Higher modules (A2, D1, E1) set procedures that need to be handled by the contractor and a notified body.

PED FOR PIPING: R-1234ZE



Pipe	Outer Diameter	DN equivalent	PED requirement for suction line, piping is protected form exceeding PS=14 bar by safety valve	PED requirement for liquid, discharge, condensate lines, piping is protected form exceeding PS=21 bar by safety valve
[-]	[mm]	[dimensionless]	[-]	[-]
Copper pipe 10 x 1 mm	10	6	Sound engineering practice, same as for A1 refrigerants	Sound engineering practice, same as for A1 refrigerants
Copper pipe 12 x 1 mm	12	8	Sound engineering practice, same as for A1 refrigerants	Sound engineering practice, same as for A1 refrigerants
Copper pipe 15 x 1 mm	15	10	Sound engineering practice, same as for A1 refrigerants	Sound engineering practice, same as for A1 refrigerants
Copper pipe 18 x 1 mm	18	10	Sound engineering practice, same as for A1 refrigerants	Sound engineering practice, same as for A1 refrigerants
Copper pipe 22 x 1 mm	22	15	Sound engineering practice, same as for A1 refrigerants	Sound engineering practice, same as for A1 refrigerants
Copper pipe 28 x 1,5 mm	28	20	Sound engineering practice, same as for A1 refrigerants	Sound engineering practice, same as for A1 refrigerants
Copper pipe 35 x 1,5 mm	35	25	Sound engineering practice, same as for A1 refrigerants	Sound engineering practice, same as for A1 refrigerants
Copper pipe 42 x 1,5 mm	42	32	Sound engineering practice, same as for A1 refrigerants	Sound engineering practice, same as for A1 refrigerants
Copper pipe 54 x 2 mm	54	40	Sound engineering practice, same as for A1 refrigerants	Sound engineering practice, same as for A1 refrigerants
Copper pipe 64x 2 mm	64	50	Sound engineering practice, same as for A1 refrigerants	Module A needs to be applied while assembling line

The term “Module...” refers to set of procedures to follow in order to ensure conformity with PED requirements while assembling piping on site:

- Module A sets procedures that can be handled by the contractor alone.
- Higher modules (A2, D1, E1) set procedures that need to be handled by the contractor and a notified body.

REFERENCES



- AREA: Introduction to Refrigeration Standard EN 378
- FETA: An introduction to A2L refrigerants and their use in Refrigeration, Air Conditioning and Heat Pump applications
- EPEE: “Grow your business – Get ready for flammable refrigerants”

APPENDIX A: IEC 60335-2-89



Equipment Covered by IEC 60335-2-89:

„Commercial refrigerating appliances with an incorporated or remote refrigerant unit or compressor”

- Display & storage cabinets
- Commercial refrigerators
- Trolley cabinets
- Serve-over and self-service counters
- Blast chillers & freezers
- Refrigerating units
- Commercial ice makers



Refrigerated display and storage cabinets



Commercial refrigerators



Refrigerated trolley cabinets



Service counters and self-service counters



Blast chillers and blast freezers



Refrigerating units

IEC 60335-2-89 is not Applicable to:

- Any appliance with a charge of flammable refrigerant exceeding the limits specified in this standard (i.e. larger charges can be used under reference to ISO 5149 / EN 378).
- Split systems having a refrigerant charge of flammable refrigerant **>150 gr.** in any refrigerating circuit.
- Cold temperature rooms
- Multiple refrigerated chambers with a remote motor-compressor
- Industrial refrigerating systems

LATEST REVISION OF IEC 60335-2-89



Current Status after Revision of April 2019

- Max. refrigerant charge per circuit in appliances with an incorporated refrigerant unit or motor-compressor = 13*LFL or 1.2 kg, whichever is less
 - R-290: 0.494 kg
 - R-455A: 1.2 kg
 - R-454C: 1.2 kg
- The refrigerant charge of flammable refrigerant in appliances with a remote refrigerant unit or motor-compressor (split system), shall not exceed 150 g in any refrigerating circuit.

Charge of flammable refrigerant in the appliance (any flammability class)	Applicable Standard
Hermetic System \leq 13*LFL (or 1.2 kg max.)	IEC 60335-2-89
Hermetic System $>$ 13*LFL (or 1.2 kg max.)	EN 378
Split System $>$ 150 g	EN 378

EN 60335-2-89 vs. IEC 60335-2-89:

- In Europe the relevant standard for CE marking is EN 60335-2-89, not IEC 60335-2-89.
- We expect it will take min. another 2 years to get the EN 60335-2-89 revised, as relevant European directives have to be implemented into the standard.

For split systems with $>$ 150g, IEC 60335-2-89 is still not applicable

EN 378 STANDARD



EN 378 Offers an Alternative to EN 60335-2-89

EN 378 alternative risk assessment can be used instead of EN 60335-2-89 risk assessment, in case refrigerant charges required are higher than planned by EN 60335-2-89.

Higher Charge limits for Hydrocarbons Require Costly System Design Changes

- IEC 60335-2-89 requires design changes to the equipment in order to ensure that the level of risk with >150 g of flammable refrigerant remains similar to the risk with <150 g. The effectiveness of design and construction must be checked using a special & complex leak test, which does not take into consideration real-life situations (in particular in public spaces) and leaves a significant safety concern.
- Cost of insurance for the OEM and the store operator may increase significantly due to the higher risk incurred by customers (non risk-trained people) and staff in the stores using A3 refrigerants.

A2L Refrigerants are Inherently Safer than A3 Refrigerants and Reduce Significantly the Risk of Ignition

- A2L bring a lower probability of ignition events due to their high LFL and high Minimum Ignition Energy (MIE) / Many potential ignition sources in an appliance will not ignite A2L refrigerants (see IEC 60335-2-40). A2L bring a lower severity to ignition events due to their low Burning Velocity and low Heat of Combustion (HOC).
- **Significantly safer for the OEM and its staff** (testing & production line filling), **for the contractor and its staff** (handling) as most events happen during servicing, and **for shoppers** (they are not risk-trained) as each system with hydrocarbons adds to the overall explosion/flammability risk and charge load of a store.
- System components for A2L refrigerants are less expensive than components for A3 refrigerants (ATEX-proof not required).

APPENDIX B: RISK ASSESSMENT CHECKLISTS



[Link to Risk Assessment Checklists](#)

INTRODUCTION

When you design, assemble, commission, service, or repair a refrigeration system, you need to ensure that the potential technical, environmental, health, and safety risks are known, evaluated and appropriately mitigated. This is valid no matter which refrigerant you use, flammable or non-flammable. Honeywell's interactive checklist will help you conduct risk assessments for your refrigeration systems. When assessing risk, our checklist will also show you that using A2L refrigerants does not require significant additional effort when compared to the use of R-744 or other A1 refrigerants.



DESIGN PHASE	System assembled from components (including refrigerant piping) on site and charged on site	System factory charged, located outdoor	System factory charged, located in ventilated enclosure (e.g. water-cooled chiller)	System factory charged, located in machinery room (e.g. water-cooled chiller)	System factory charged, located indoor (e.g. plug-in cabinet, monobloc)
Does the design team have the final layout of the facility?					
For rooms featuring refrigerant containing parts: Are the access categories known?					
Is the system location defined?					
In case of refrigerant leak: Is refrigerant flow into the building prevented?					
Refrigerant charge of the system: Is it calculated and cross-checked according to the standard?					
Are the locations of designed pipe network coordinated with other systems within the facility?					
Sub point: Is the vicinity of pipe runs & valve stations with hot surfaces and ignition sources avoided?					
Are the locations of designed components coordinated with other systems/ structures within the facility?					
Sub point: Is the vicinity of system components with hot surfaces and ignition sources avoided?					
Sub point: Is the interference of refrigerant containing parts with stairways, entrances etc. avoided?					
If applicable: Is one additional measure for QLMV < charge < QLAV defined?					
Sub point: Is the party responsible to install this additional measure defined?					
Item valid for A2L only					
DESIGN	COMPONENTS ORDERING	ASSEMBLING	COMMISSIONING	SERVICING/REPAIRING	

APPENDIX C: REQUIREMENTS FOR ALTERNATIVE PROVISIONS



Where permitted, the designer can choose to calculate the allowable refrigerant charge using the RCL, QLMV or QLAV values. These alternative provisions can only be used for an occupied space which fulfils all of the following conditions:

- Refrigerant classification A1 or A2L.
- Refrigerant charge does not exceed 195 x LFL (84 kg for R-455A, or 60 kg for R-1234ze).
- System location class II.
- Indoor heat exchange and control designed to prevent damage due to ice formation.
- Indoor unit designed to prevent damage from fan.
- Systems where only permanent joints are used in the occupied space in question except for site-made joints directly connecting the indoor unit to the piping.
- Systems where the refrigerant-containing pipes in the occupied space in question are installed in such way that it is protected against accidental damage in accordance with EN 378-2:2015, 6.2.3.3.4 and EN 378-3:2015, 6.2.
- Doors of the occupied space are not tight-fitting.
- Alternative provisions to ensure safety are provided in accordance with C.3.2.2 and C.3.2.3.
- Effect of flow down is mitigated in accordance with C.3.2.4.

Provided all of the above conditions are fulfilled, the maximum charge is calculated on the following basis:

- ▶ The total charge of the system divided by the room volume shall not exceed the QLMV value
- ▶ If the value exceeds the QLMV, **one safety measure** shall be taken.
- ▶ If the value exceeds the QLAV, **two safety measures** shall be taken.



REQUIREMENTS FOR ALTERNATIVE PROVISIONS

| SAFETY MEASURES PART 1

These additional measures only apply to systems described in Part 1 Annex C.3.

Ventilation

- The ventilation of machinery rooms shall be sufficient both for normal operating conditions and emergencies.
- This ventilation system shall be independent of any other ventilation system on the site.
- Provision shall be made for a sufficient supply of outside replacement air and a good distribution of that air over the machinery room avoiding dead zones.
- Openings for outside air shall be positioned to avoid re-circulation into the room.
- Ventilation for normal operating conditions or when machinery room is occupied shall be in accordance with national regulations with a minimum of 4 air changes per hour.
- the emergency mechanical ventilation system shall be activated by a detector(s), located in the machinery room. The detector(s) shall be as specified in clause 9.
- An emergency ventilation system with 15 air changes per hour is sufficient.
- In the event that the necessary ventilation rate cannot be achieved an audible and/or visual alarm shall be initiated and, where relevant, electrical supplies shall be terminated.
- The emergency exhaust ventilation fan shall be either:
 - in the air flow with the motor outside the airflow, or
 - rated for hazardous areas as required in EN 378-2:2015, 6.2.14.
- The fan shall not cause sparks to occur if it contacts the duct material
- For doors communicating to other areas inside the building and where the gas detector is not able to detect refrigerants when these doors are opened, emergency ventilation shall be initiated when a door is opened for more than 60 seconds.

REQUIREMENTS FOR ALTERNATIVE PROVISIONS

| SAFETY MEASURES PART 2



These additional measures only apply to systems described in Part 1 Annex C.3.

Safety Alarms

- If alarms are employed to warn of a leak in the machinery room or the occupied space the alarm shall warn of a refrigerant leak in accordance with Clause 8.3 of EN 378 Part 3. The alarm shall be turned on by the signal from the detector in accordance with Clause 9. The alarm shall also alert an authorized person to take appropriate action.
- In cases where an alarm system is installed the power source of the alarm system shall be from a power source independent of the mechanical ventilation or other refrigerating systems which the alarm system is protecting.
- The alarm system shall warn both audibly and visibly such as both a loud (15 dB(A) above the background level) buzzer and a flashing lamp.
- For a machinery room the alarm system shall warn both inside and outside the machinery room. The alarm outside the machinery room may be installed in a supervised location.
- For an occupied space the alarm system shall warn at least inside the occupied space.
- For access category a, the alarm system shall also warn at a supervised location such as the night porter's location as well as the occupied space.

REQUIREMENTS FOR ALTERNATIVE PROVISIONS

| SAFETY MEASURES PART 3



These additional measures only apply to systems described in Part 1 Annex C.3.

Safety Shut Off Valves

- In the event of refrigerant leak, the valves shall shut off the refrigerant so that the amount of refrigerant leaked into the occupied space is less than the QLMV value in the occupied space.
- Valves shall isolate the refrigeration circuit from the occupied space under the control of a detector in accordance with Clause 9.
- The manufacturer or installer of the equipment shall provide the data necessary to calculate the amount of refrigerant that may leak into the occupied space.
- The data shall include the location of the valve in the refrigeration system and the position of the detectors in the relevant rooms. The data shall be included in the installation documentation according to 6.4.3.1 of EN 378-2:2015.
- Shut off valves shall be located outside of the occupied space and shall be positioned to enable access for maintenance by an authorized person.
- Valves shall be designed to close in the event of an electric power failure e.g. spring return solenoid valves.
- Valves in the refrigeration circuit shall be able to shut off the refrigerant flow in the event of a leak of refrigerant without unduly affecting the refrigerant flow in normal operation.



REQUIREMENTS FOR ALTERNATIVE PROVISIONS

| SAFETY MEASURES PART 4

These additional measures only apply to systems described in Part 1 Annex C.3.

Detectors

- A refrigerant detector for group A2L refrigerant shall activate the alarm signal at a level not exceeding 25% of the LFL of the refrigerant. The detector shall continue to activate at higher concentrations. The detector shall be set lower for the toxicity, if applicable (see 8.1). It shall automatically activate an alarm, start mechanical ventilation and stop the system when it triggers.
- The pre-set value for the refrigerant detector shall be set to 25% of the LFL or 50% of the ATEL/ODL, whichever is the lower value, as given in Annex E of EN 378-1:2015. The pre-set value for the oxygen deprivation detector shall be 18 % or higher.
- The location and positioning of detectors shall be chosen in relation to the refrigerant and they shall be located where the refrigerant from the leak will concentrate, with due consideration of local airflow patterns.
- **R-455A and HFOs are heavier than air and in case of leakage they tend to fall on the ground and spread along the ground level. This should be taken into consideration for proper placement of detectors.**
- At least one detector shall be installed in each machinery room or the occupied space being considered and/or at the lowest underground room for refrigerants heavier than air.
- Any suitable detector may be used and shall give an electrical signal at the pre-set value of the refrigerant or oxygen concentration (the pre-set value) that activates the shut-off valves, the alarm system, the mechanical ventilation or other emergency controls.
- In the case of a detector failure, the emergency sequence should be activated as if refrigerant had been detected.

DISCLAIMER



Although Honeywell International Inc. believes that the information contained herein is accurate and reliable, it is presented without guarantee or responsibility of any kind and does not constitute any representation or warranty of Honeywell International Inc., either expressed or implied.

A number of factors may affect the performance of any products used in conjunction with user's materials, such as other raw materials, application, formulation, environmental factors and manufacturing conditions among others, all of which must be taken into account by the user in producing or using the products. The user should not assume that all necessary data for the proper evaluation of these products are contained herein. Information provided herein does not relieve the user from the responsibility of carrying out its own tests and experiments, and the user assumes all risks and liabilities (including, but not limited to, risks relating to results, patent infringement, regulatory compliance and health, safety and environment) related to the use of the products and/or information contained herein.

**THANK
YOU**



Honeywell